

# TOSHIBA



## Color Television

36A61

Owner's Manual  
COLORSTREAM®

Welcome to  
Toshiba

Connecting  
your TV

Using the  
Remote Control

Setting up  
your TV

Using the TV's  
Features

Appendix

## SAFETY PRECAUTIONS

### WARNING

**TO REDUCE THE RISK OF FIRE OR ELECTRIC SHOCK, DO NOT EXPOSE THIS APPLIANCE TO RAIN OR MOISTURE.**



The lightning symbol in the triangle tells you that the voltage inside this product may be strong enough to cause an electric shock. **DO NOT TRY TO SERVICE THIS PRODUCT YOURSELF.**



The exclamation mark in the triangle tells you that important operating and maintenance instructions follow this symbol.

### CAUTIONS

TO PREVENT ELECTRIC SHOCK, DO NOT USE THIS POLARIZED PLUG WITH AN EXTENSION CORD RECEPTACLE OR OTHER OUTLET UNLESS THE PRONGS CAN BE FULLY INSERTED INTO THE OUTLET TO PREVENT ANY EXPOSURE OF THE PRONGS ON THE POLARIZED PLUG.

### PRECAUCIONES

PARA EVITAR DESCARGAS ELÉCTRICAS, NO UTILICE ESTE ENCHUFE POLARIZADO CON UN RECEPTÁCULO DE CABLE DE EXTENSIÓN U OTRA TOMA SALVO QUE LA CLAVIJA ESTÉ COMPLETAMENTE INSERTADA EN LA TOMA PARA EVITAR CUALQUIER EXPOSICIÓN DE LOS VÁSTAGOS DEL ENCHUFE POLARIZADO.

### WARNING

To avoid personal injury:

- Do not stand or climb on the TV.
- Do not put a VCR or any heavy object on top of the TV.

### ADVERTENCIA

Para evitar daños personales:

- No se ponga de pie en el TV ni suba a él.
- No coloque el video (p. ej. VCR) ni otro objeto pesado en la parte superior del TV.

Avoid displaying stationary images on your TV screen for extended periods of time. Stationary patterns generated by a picture-in-picture (PIP) display, computer displays, video games, stock market reports, etc., can become permanently engrained on the picture tube. This damage is not protected by your warranty because it is the result of misuse. If you wish to use your TV to display still images, reduce brightness and contrast settings. Never leave a PIP, computer, or video game display unattended.

**Use this TV set with the Toshiba stand listed on page 38 only. Use with other stands may result in instability, causing possible injury or death.**

#### *Note to CATV system installers in the USA*

This reminder is provided to call the CATV system installer's attention to Article 820-40 of the NEC, which provides guidelines for proper grounding, and, in particular, specifies that the cable ground shall be connected to the grounding system of the building, as close to the point of cable entry as practical.

## IMPORTANT SAFETY INSTRUCTIONS

## INSTRUCCIONES DE SEGURIDAD

### CAUTION

PLEASE READ AND OBSERVE ALL WARNINGS AND INSTRUCTIONS CONTAINED IN THIS SECTION AND THOSE ON YOUR TV SET.

RETAIN THIS SECTION FOR REFERENCE.

### PRECAUCIÓN

LEA Y TENGA EN CUENTA TODAS LAS ADVERTENCIAS E INSTRUCCIONES QUE SE ENCUENTRAN EN ESTE PANFLETO Y LAS DE LOS APARATOS DE TELEVISIÓN.

MANTENGA ESTE PANFLETO PARA FUTURAS REFERENCIAS.

Electrical energy can perform many useful functions. This TV set has been engineered and manufactured to assure your personal safety. However, improper use can result in potential electrical shock or fire hazards. In order not to defeat the safeguards incorporated in this TV set, observe the following basic rules for antenna/TV installation, use and servicing.

**Do not remove the cabinet cover. This may expose you to dangerous voltages. Refer all servicing to qualified service personnel.**

La energía eléctrica puede realizar funciones muy útiles. Este televisor ha sido diseñado y fabricado para asegurar su seguridad personal. Sin embargo, la utilización inadecuada del mismo puede resultar en descargas eléctricas o en el riesgo de incendios. Para no anular las protecciones incorporadas en este televisor, tenga en cuenta las reglas básicas de instalación de la antena/televisor, y en caso de problemas póngase en contacto con un centro de reparaciones.

**No extraiga de la cubierta de la caja. Esto podría dejarle expuesto a tensiones peligrosas. En caso de avería, consulte los servicios de personal cualificado.**

### INSTALLATION / INSTALACIÓN

**Power Sources** — The TV set should be operated only from the type of power source indicated on the TV set or as indicated in the Owner's Manual. If you are not sure of the type of power supply in your home, consult your sales person or your local power company. For TV sets designed to operate from battery power, refer to the operating instructions.

**Fuentes de alimentación** — Este televisor solamente deberá alimentarse con la fuente de alimentación indicada en la etiqueta de características. Si no está seguro del tipo de fuente de alimentación de su hogar, consulte al proveedor de su televisor o a la compañía eléctrica local. Para productos destinados a alimentarse con pilas, u otras fuentes, consulte las instrucciones de operación.

**Grounding or Polarization** — The TV set is equipped with one of the following type plugs. If the plug should fail to fit the power outlet, contact your electrician to replace your obsolete outlet. **DO NOT** defeat the safety purpose of the type plug on the TV set.

**Puesta a tierra o polarización** — Este televisor puede poseer un enchufe de los tipos siguientes. Si el enchufe no entra en la toma de la red, póngase en contacto con un electricista para que le cambie la toma anticuada. **NO** anule el fin de seguridad de sete tipo de enchufe del televisor.

A polarized alternating current line plug — having one blade wider than the other. This plug will fit into the power outlet only one way. If you are unable to insert the plug into the outlet, try reversing the plug.

Un enchufe de línea de corriente alterna polarizado — posee una cuchilla más ancha que la otra. Este enchufe entrará en la toma de la red de una sola forma. Si no puede insertar el enchufe en la toma de la red, trate de invertirlo.

**Alternate Warnings** — A three-wire grounding-type plug — a plug having a third (grounding) pin. This plug will only fit into grounding-type power outlet.

**Advertencias alternativas** — Enchufe de tipo puesta a tierra de tres conductores — enchufe que posee un tercer terminal (de puesta a tierra). Este enchufe solamente encajará en una toma de la red de tipo puesta a tierra.

**Water and Moisture** — Do not use the TV set near water — for example, near a bath tub, wash bowl, kitchen sink, or laundry tub; in a wet basement; or near a swimming pool; and the like.

**Agua y humedad** — No utilice el televisor cerca del agua — por ejemplo, cerca de una bañera, un lavabo, un fregadero, una lavadora, en un sótano húmedo, cerca de una piscina, ni lugares por el estilo.

**Ventilation** — The slots and openings in the cabinet and in the back or bottom are provided for necessary ventilation. Never block or cover these slots and openings to ensure reliable operation of the TV set and to protect it from overheating.

**Ventilación** — Las ranuras y aberturas de la caja y de la parte posterior o de la base son para proporcionar la ventilación necesaria. Para asegurar la operación fiable del televisor para protegerlo contra el recalentamiento. No bloquee ni cubra nunca estas ranuras y aberturas.

- a. Never cover the slots and openings with a cloth or other materials.
- a. No cubra nunca las ranuras ni las aberturas con paños ni otros materiales.
- b. Never block the slots and openings by placing the TV set on a bed, sofa, rug or other similar surface.
- b. No bloquee nunca las ranuras ni las aberturas colocando el televisor sobre una cama, un sofá, una alfombra, ni demás superficies similares.
- c. Never place the TV set in a confined space such as a bookcase, built-in cabinet, or any other place of poor ventilation.
- c. No coloque nunca el televisor en un espacio cubierto, como una librería o un estante empotrados, ni en un lugar de mala ventilación.

**Heat** — Do not place the TV set near or over a radiator or heat register, or where it is exposed to direct sunlight.

**Calor** — No coloque el televisor cerca ni sobre un radiador ni un registro de calor, ni expuesto a la luz solar directa.

**Power-Cord Protection** — Do not allow anything to rest on or roll over the power cord, and do not place the TV set where the power cord is subject to wear or abuse.

**Protección del cable de alimentación** — No coloque ni pase sobre el cable de alimentación, ni coloque el televisor donde su cable de alimentación pueda sufrir cualquier tipo de daños.

**Accessories** — Do not place the TV set on an unstable cart, stand, tripod, bracket, or table. The TV set may fall, causing serious injury to a child or adult, and serious damage to the TV set. Use only with a cart, stand, tripod, bracket, or table recommended by the manufacturer, or sold with the TV set, and should use a mounting accessory recommended by the manufacturer.

**Accesorios** — No coloque el televisor sobre un carrito, una base, un trípode, un soporte ni una mesa inestable. El televisor podría caerse, causando serios daños a niños o adultos, o al propio televisor. Utilice solamente el carrito, la base, el trípode, el soporte, o la mesa que recomiende el fabricante, o que se venda con el televisor, y utilice un accesorio de montaje recomendado por el fabricante.

A product and cart combination should be moved with care. Quick stops, excessive force, and uneven surfaces may cause the product and cart combination to overturn.

La combinación de un producto y un carrito deberá moverse con cuidado. Las paradas repentinas, la fuerza excesiva, y las superficies desiguales pondrían hacer que volcarse la combinación del carrito y del producto.



## USE / UTILIZACIÓN

**Overloading** — Do not overload wall outlets, extension cords or convenience receptacles beyond their capacity, since this can result in fire or electric shock.

**Sobrecarga** — No sobrecargue las tomas de la red, los cables prolongadores, ni los adaptadores para múltiples tomas, ya que esto supondría el riesgo de incendios o de descargas eléctricas.

During lightning storms, or when the TV set will be left unattended and unused for a long period of time, unplug the power cord from the wall outlet and disconnect the antenna or cable system. This will prevent damage to the TV set due to lightning and power-line surges.

Durante tormentas eléctricas, o cuando no vaya a utilizar el televisor durante mucho tiempo, desenchufe el cable de alimentación de la toma de la red y desconecte la antena o el sistema de cablevisión. Esto evitará que se dañe el televisor debido a rayos y a sobretensiones repentinas en la red.

**Object and Liquid Entry** — Never push objects of any kind into the TV set through the cabinet slots as they may touch dangerous voltage points or short out parts that could result in a fire or electric shock. Never spill liquid of any kind on the TV set.

**Entrada de objetos y líquidos** — No introduzca nunca objetos de ningún tipo en este televisor a través de las aberturas, ya que podrían tocar puntos de tensión peligrosa o cortocircuitar piezas, lo que podría resultar en incendio o descarga eléctrica. No vierta nunca líquidos de ningún tipo sobre este televisor.

**Cleaning** — Unplug the TV set from the wall outlet before cleaning or polishing it. Do not use liquid cleaners or aerosol cleaners. Use a cloth lightly dampened with water for cleaning the exterior of the TV set.

**Limpieza** — Desenchufe el televisor de la toma de la red antes de limpiarlo. No utilice limpiadores líquidos ni aerosoles. Para limpiar el exterior del televisor, utilice un paño ligeramente humedecido en agua.

**Attachments** — Never add accessories that have not been specifically designed for the TV set. Never remodel the TV set by yourself as this can result in a fire hazard or electric shock.

**Aditamentos** — No utilice aditamentos no recomendados por el fabricante del televisor, ya que podrían suponer un peligro. No remodele nunca el televisor usted mismo, ya que esto podría causar el riesgo de incendios o descargas eléctricas.

If a snapping or popping sound from a TV set is heard continuously or frequently while the TV set is operated, unplug the TV set and consult your dealer or service technician. It is normal for some TV sets to make occasional snapping or popping sounds, particularly when being turned on or off.

Si se oye un sonido seco de un televisor continuo o frecuente mientras el televisor esté funcionando, desenchúfelo y consulte a su proveedor o a un técnico de servicio. Es normal que algunos televisores produzcan sonidos secos, particularmente cuando conecte o desconecte su alimentación.

## SERVICE / SERVICIO DE REPARACIÓN

**Damage Requiring Service** — Unplug the TV set from the wall outlet and refer servicing to qualified service personnel under the following conditions:

**Daños que requieren el servicio de reparación** — En los casos siguientes, desenchufe el televisor de la toma de la red y solicite los servicios de personal de reparación especializado:

- a. When the power cord or plug is damaged or frayed.  
a. Cuando se haya dañado el cable de alimentación o el enchufe.
- b. When liquid has been spilled into the TV set.  
b. Cuando se haya vertido líquido dentro del televisor.
- c. When the TV set has been exposed to rain or water.  
c. Cuando el televisor haya estado expuesto a la lluvia o al agua.
- d. When the TV set has been subject to excessive shock by being dropped, or the cabinet has been damaged.  
d. Cuando el televisor haya estado expuesto a golpes excesivos o haya caído, o su caja se haya dañado.
- e. When the TV set does not operate normally even though you follow the operating instructions. Adjust only those controls that are specified in the operating instructions. Improper adjustment of other controls may result in damage and will often require extensive work by a qualified technician to restore the TV set to normal operation.  
When the TV set exhibits a distinct change in performance. This indicates a need for service.  
e. Cuando el televisor no funcione normalmente incluso al seguir las instrucciones de operación. Ajuste solamente los controles indicados en las instrucciones de operación, ya que un ajuste inadecuado de otros controles podría resultar en daños y a menudo requerirán un trabajo difícil por un técnico cualificado para devolver el televisor a su funcionamiento normal.

Cuando el funcionamiento del televisor haya cambiado notablemente — esto indica la necesidad del servicio de reparación.

**Servicing** — Do not attempt to service the TV set yourself. To open or remove the covers may expose you to dangerous voltage or other hazards. Refer all servicing to qualified service personnel.

**Reparación** — No intente nunca reparar el televisor por sí mismo. La apertura o extracción de cubiertas podría exponerle a tensiones peligrosas u otros peligros. En caso de avería solicite los servicios de personal de reparación cualificado.

**Replacement Parts** — When replacement parts are required, be sure the service technician certifies in writing that he has used replacement parts specified by the manufacturer that have the same characteristics as the original parts. Unauthorized substitutions may result in fire, electric shock, or other hazards.

**Reemplazo de piezas** — Cuando sea necesario reemplazar piezas, cerciórese de que el técnico de reparación utilice las piezas de reemplazo especificadas por el fabricante u otras que posean las mismas características que las originales. Las substituciones no autorizadas podrían resultar en incendios, descargas eléctricas, u otros peligros.

**Safety Check** — Upon completion of any service or repairs to the TV set, ask the service technician to perform routine safety checks (as specified by the manufacturer) to determine that the TV set is in safe operating condition, and to so certify.

**Comprobación de seguridad** — Al finalizar cualquier reparación de este televisor, solicite al técnico de reparación que realice las comprobaciones de seguridad (especificadas por el fabricante) para determinar y certificar si el producto se encuentra en las condiciones de operación apropiadas.

When the TV set reaches the end of its useful life, improper disposal could result in a picture tube implosion. Ask a qualified service technician to dispose of the TV set.

Cuando el televisor llegue al final de su vida útil, si se deshace de él de forma inapropiada, el tubo de imagen puede explotar. Cuando desee deshacerse de un televisor, solicite este servicio a un técnico de reparación especializado.

## ANTENNA / ANTENA

**Outdoor Antenna Grounding** — If an outdoor antenna is installed, follow the precautions below.

An outdoor antenna system should not be located in the vicinity of overhead power lines or other electric light or power circuits, or where it can come in contact with such power lines or circuits.

WHEN INSTALLING AN OUTDOOR ANTENNA SYSTEM, EXTREME CARE SHOULD BE TAKEN TO KEEP FROM CONTACTING SUCH POWER LINES OR CIRCUITS AS CONTACT WITH THEM IS ALMOST INVARIABLY FATAL.

Be sure the antenna system is grounded so as to provide some protection against voltage surges and built-up static charges. Section 810 of the National Electrical Code in the USA and Section 54 of the Canadian Electrical Code in Canada provides information with respect to proper grounding of the mast and supporting structure, grounding of the lead-in wire to an antenna discharge unit, size of grounding conductors, location of antenna discharge unit, connection to grounding electrodes, and requirements for the grounding electrode.

**Puesta a tierra de la antena exterior** — Cuando instale una antena exterior, tenga en cuenta las precauciones siguientes.

Un sistema de antena exterior no deberá colocarse cerca de líneas de alta tensión ni otros circuitos de iluminación o alimentación, ni donde pueda entrar en contacto con tales líneas o circuitos.

CUANDO INSTALE UN SISTEMA DE ANTENA EXTERIOR, TENGA EXTREMADO CUIDADO PARA EVITAR QUE ENTRE EN CONTACTO CON TALES LÍNEAS DE ALIMENTACIÓN O CIRCUITOS, YA QUE TAL CONTACTO PODRÍA RESULTAR INVARIABLEMENTE FATAL.

Cerciórese de que el sistema de antena esté puesto a tierra a fin de que proporcione cierta protección contra sobretensiones y cargas estáticas. La Sección 810 del Código Eléctrico Nacional (NEC) de EE.UU. y la Sección 54 del Código Eléctrico Canadiense ofrecen información con respecto a la puesta a tierra adecuada de una unidad de descarga de antena, el tamaño de los conductores de puesta a tierra, la ubicación de la unidad de descarga de la antena, la conexión de los electrodos de puesta a tierra, y los requisitos de tales electrodos.

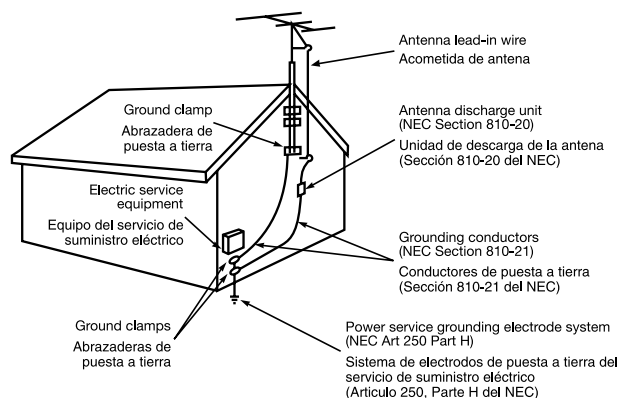

<b>Welcome to Toshiba .....</b>	<b>6</b>	Using the V-Chip Control (blocking) feature .....	20
Exploring your new TV .....	6	Selecting a PIN code .....	20
Selecting a location for the TV .....	6	Changing your PIN code .....	21
<b>Notice of possible TV stand instability .....</b>	<b>6</b>	Blocking programs by ratings .....	22
<b>Connecting your TV .....</b>	<b>7</b>	Ratings definitions (MPAA, Youth TV, TV) .....	22
<b>Note regarding picture quality .....</b>	<b>7</b>	Unblocking programs temporarily .....	23
Connecting a VCR .....	7	Blocking unrated movies and programs .....	23
Connecting a cable converter box .....	8	Blocking channels .....	24
Connecting a cable converter box and VCR .....	8	Locking video inputs .....	25
Connecting a DVD player or satellite receiver and a VCR .....	9	Channel labels .....	26
Connecting a DVD player with ColorStream™ (component video) and a VCR .....	10	Video labels .....	27
Connecting two VCRs .....	10	Watching picture-in-picture (PIP) .....	28
Connecting a camcorder .....	11	Switching the main and small pictures .....	28
Connecting an audio amplifier .....	11	Changing the location of the PIP window .....	29
<b>Using the remote control .....</b>	<b>12</b>	Freezing the PIP display .....	29
Preparing the remote control for use .....	12	Watching multi-window PIP .....	29
Installing the remote control batteries .....	12	Adjusting the picture .....	30
Using the remote control with a Toshiba VCR or cable TV converter .....	12	Adjusting the picture quality .....	30
Programming the remote control for use with a non-Toshiba VCR or cable TV converter .....	13	Selecting the color temperature .....	30
VCR code table .....	13	Adjusting the picture preference .....	31
Cable TV converter code table .....	14	Displaying on-screen information .....	31
Learning about the remote control .....	15	Setting the off timer .....	31
<b>Setting up your TV .....</b>	<b>16</b>	Auto power off .....	31
Changing the on-screen display language .....	16	Using the closed caption feature .....	32
Selecting the antenna input .....	16	Adjusting the sound .....	33
Selecting the signal source .....	17	Muting the sound .....	33
Watching video input .....	17	Selecting stereo/SAP broadcasts .....	33
Programming channels into the TV's memory .....	17	Adjusting the sound quality .....	34
Programming channels automatically .....	17	Using the surround sound feature .....	34
Adding and erasing channels manually .....	18	Selecting variable audio OUT .....	35
Changing channels .....	18	Turning off the built-in speakers .....	35
<b>Using the TV's features .....</b>	<b>19</b>	Using the sub-bass system (SBS) .....	36
Adjusting the channel settings .....	19	Viewing the demonstration (DEMO) mode .....	36
Switching between two channels .....	19	Understanding the last mode memory feature .....	36
Programming your favorite channels .....	19	<b>Appendix .....</b>	<b>37</b>
		Troubleshooting .....	37
		Cleaning and care .....	38
		Specifications .....	38
		Limited United States warranty .....	39
		Attention Canadian customers .....	39

## Welcome to Toshiba

Congratulations! You have purchased one of the finest color TVs on the market. The goal of this manual is to guide you through setting up and operating your Toshiba TV as quickly as possible. Please make sure you have received the following items: TV, remote control, batteries, owner's manual, registration card, and extended service plan literature. If you did not receive all of the items or if any of the items are damaged or broken, please contact your Toshiba dealer. In addition, you may need to purchase other audio or video cables to connect your equipment. See "Connecting your TV" on page 7 for more information.

Please read all safety and operating instructions carefully before you proceed.

### Exploring your new TV

You can operate your TV using the buttons on the front panel or the remote control. The back panel provides all the terminal connections you will need to connect other equipment to your TV.

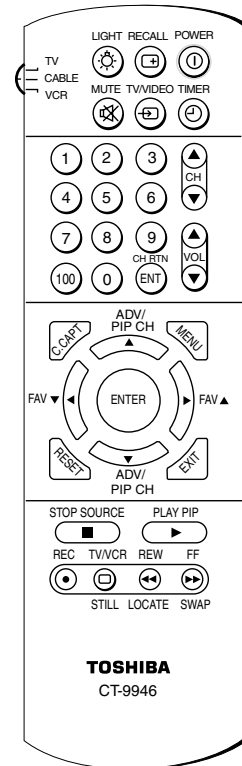
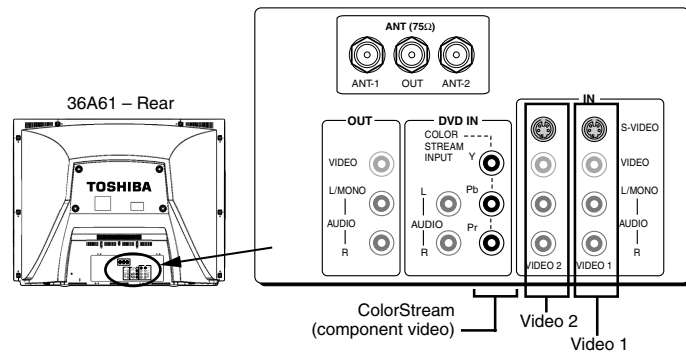
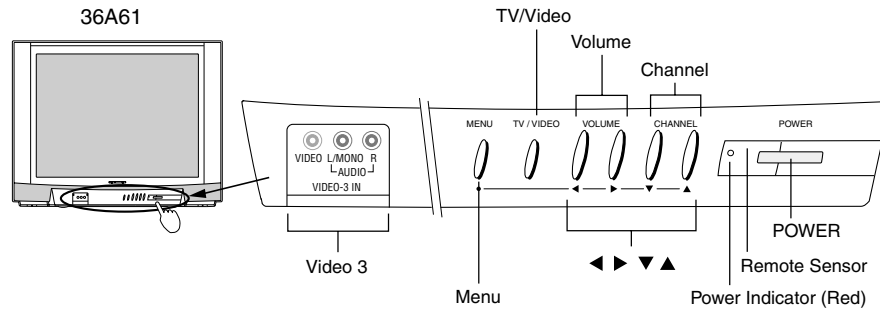

#### Caution:

The plug has one prong wider than the other and will fit only one way into a standard electrical outlet (120 volt AC, 60 Hz). If the plug does not fit into the outlet, try turning it around. If the plug still does not fit, the outlet is probably non-standard and must be replaced by a qualified electrician. **Do not tamper with the plug or try to force it into a non-standard outlet.**

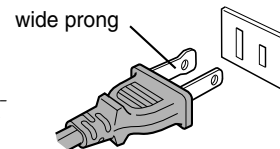

### Selecting a location for the TV

- Place the TV on the floor or on the recommended TV stand (see "Notice of Possible TV Stand Instability" at right).
- Place the TV in a location where light does not directly hit the screen.
- Place the TV far enough from the walls to allow proper ventilation. Inadequate ventilation may cause overheating, which may damage the TV.

The serial number is on the back of your TV. Record the number in the space below. Refer to the model and serial numbers whenever you communicate with your Toshiba dealer about this TV.

Model number: **36A61**

Serial number: \_\_\_\_\_

#### NOTICE OF POSSIBLE TV STAND INSTABILITY



**WARNING: RISK OF SERIOUS PERSONAL INJURY OR DEATH!**

Use your TV with the Toshiba TV stand recommended below **only!**

Use with other stands may result in instability, causing possible injury or death.

TV Model	TV Stand
36A61	ST3641

## Connecting your TV

If you have not connected electronic equipment before, or you have been frustrated in the past, you may wish to read this section.

**Note:** Cables are not supplied.

- A coaxial cable is the standard cable that comes in from your antenna or cable converter box. Coaxial cables use “F” connectors.
- Audio and video cables are usually color coded according to use: yellow for video; red and white for audio. The red audio cable is for the stereo right channel; the white audio cable is for the stereo (or mono) left channel. If you look at the rear panel of the TV, you will see that the terminals are color coded in the same manner as the cables.
- S-video cables provide better picture performance than standard video cables. S-video cables can be used only with S-video compatible components.
- ColorStream™ (component video) cables come in sets of three. A ColorStream (component video) connection will provide the best picture performance.

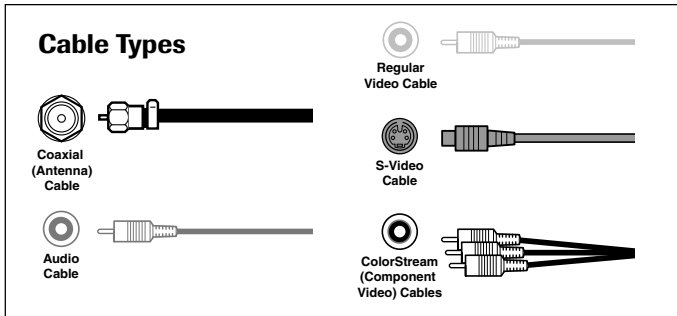

## Connecting a VCR

This connection allows you to watch local channels and video programs, play or record on the VCR while watching TV, and record from one channel while watching another channel.

**You will need:**

- one coaxial cable
- one pair of audio cables (one single audio cable for a mono VCR)
- one video cable

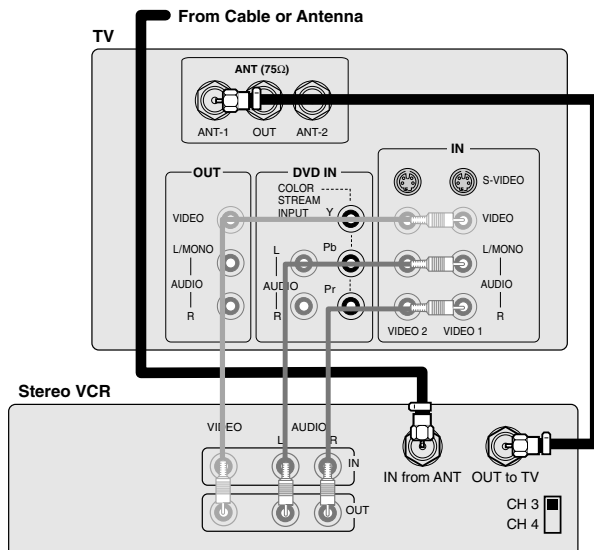

### NOTE REGARDING PICTURE QUALITY

**When connecting video equipment, such as a VCR or DVD player:**

- For **GOOD** picture quality: Use regular video cables.
- For **BETTER** picture quality: If your equipment has S-video connections, use S-video cables instead of regular video cables.
- For **BEST** picture quality: If your equipment has ColorStream (component video) connections, use component video cables instead of regular or S-video cables. Component video cables come in sets of three.

**Note:** Do not connect a regular video cable and an S-Video cable to VIDEO-1 (or VIDEO-2) at the same time. Doing so will distort the picture.

### Caution:

Do not plug in any power cords until you have finished connecting all of your equipment.

### Note:

If you have a mono VCR, connect L/Mono to VCR Audio OUT using only one audio cable.

If you have an S-VHS VCR, use an S-video cable instead of a regular video cable.

Do not connect a regular video cable and an S-video cable to Video-1 (or Video-2) at the same time. Doing so will distort the picture.

## Connecting a cable converter box

This connection allows you to watch basic and premium cable channels. To use the TV features (such as PIP swap, channel ▲▼, channel block, favorite channels, or channel labels), select ANT-1. To view premium channels, select ANT-2, tune the TV to channel 3 or 4 (whichever channel is vacant in your area), and use the converter box to change channels.

### You will need:

- two coaxial cables

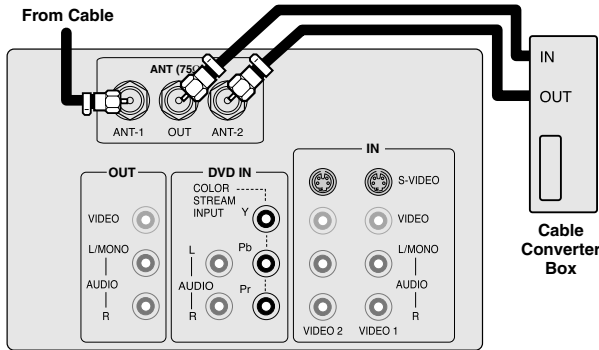

### Note:

When you use a converter box with your TV, the remote control may not operate certain features, such as PIP swap, channel ▲▼, channel block, favorite channels, or channel labels.

## Connecting a cable converter box and VCR

This connection allows you to watch and record basic and premium cable channels, as well as watch videotapes. Set the TV signal source to Video1 (see “Watching video input” on page 17). Tune the VCR to channel 3 or 4 (the same channel as the converter box output switch), and use the cable converter box to change channels. Set the PIP source to “TV” (see page 28).

### You will need:

- three coaxial cables
- one pair of audio cables (one single audio cable for a mono VCR)
- one video cable
- one cable splitter

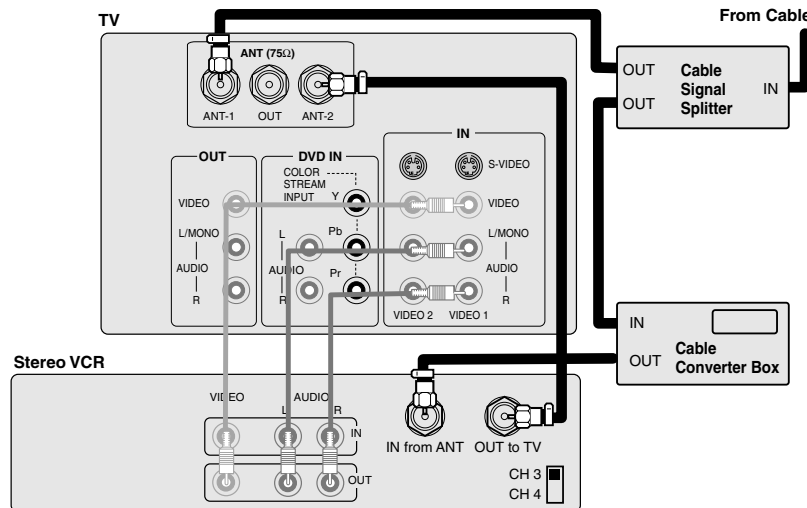

### Note:

When you use a converter box with your TV, the remote control may not operate certain features, such as PIP swap, channel ▲▼, channel block, favorite channels, or channel labels.

If you have a mono VCR, connect L/Mono to VCR Audio OUT using only one audio cable.

If you have an S-VHS VCR, use an S-video cable instead of a regular video cable.

Do not connect a regular video cable and an S-video cable to Video-1 (or Video-2) at the same time.



## Connecting a DVD player or satellite receiver and a VCR

This connection allows you to watch DVD/satellite, VCR, or TV programs. You can record from the DVD player/satellite receiver or TV. You can also record one TV channel while watching another channel.

**Note:** If your DVD player has component video connections, follow the connection instructions under “Connecting a DVD player with ColorStream™ (component video) and a VCR” on page 10.

### You will need:

- one coaxial cable
- three pairs of audio cables (one pair and two single audio cables for a mono VCR)
- two regular video cables
- one S-video cable

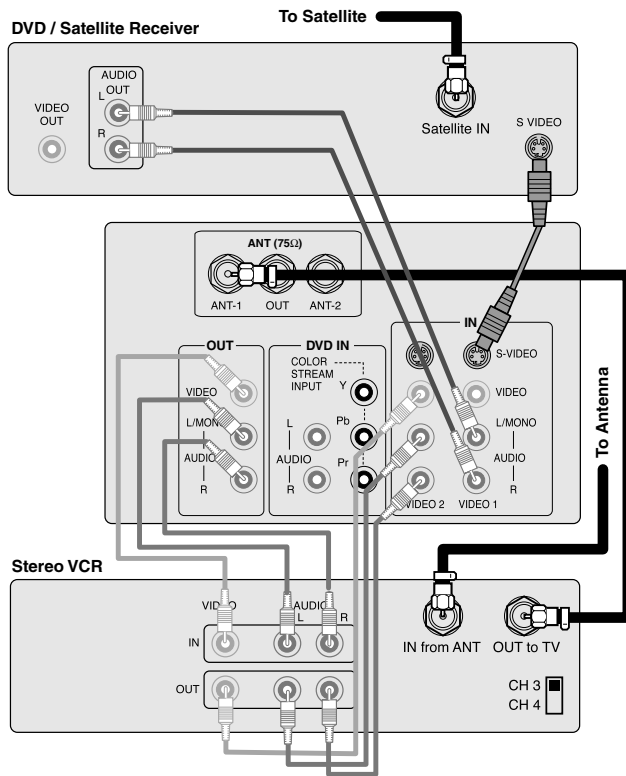

### Note:

You can use a regular video cable instead of an S-video cable between the TV and DVD player/satellite receiver, but the picture quality will decrease.

The illustration at left shows one S-video cable and one pair of audio cables connected from the DVD player/satellite receiver to Video-1 on the TV.

Do not connect a regular video cable and an S-video cable to Video-1 (or Video-2) at the same time. Doing so will distort the picture.

**When recording, set Audio Out to FIX (see “Selecting variable audio OUT” on page 35). With Audio Out set to FIX, the TV’s volume setting during recording will not affect the sound level being recorded.**

## Connecting a DVD player with ColorStream™ (component video) and a VCR

This connection allows you to watch DVD, VCR, or TV programs, and record DVD or TV programs (when authorized). You can record from one source while watching a program from another source. Your TV has ColorStream (component video) connections. Connecting your TV to a component video compatible DVD player (such as a Toshiba DVD player with ColorStream™) can greatly enhance picture quality and performance.

### You will need:

- one coaxial cable
- three pairs of audio cables (one pair and two single audio cables for a mono VCR)
- two regular video cables
- one set of ColorStream (component) video cables

### Note:

For the best picture performance, use ColorStream (component video) cables between the TV and DVD player. To record from the DVD player, the DVD player and TV must select VIDEO 1.

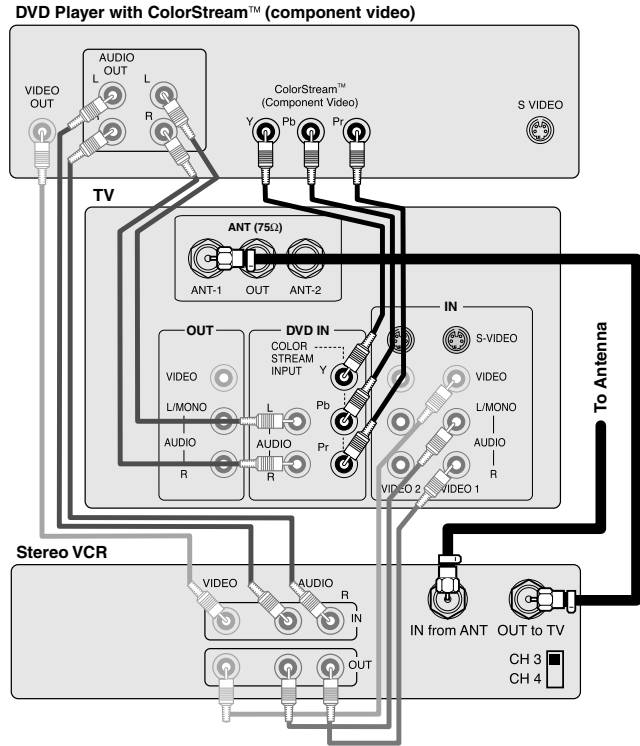

## Connecting two VCRs

This connection allows you to record from one VCR to another VCR while watching a video program. You can also record from one TV channel while watching another channel.

### You will need:

- one coaxial cable
- two pairs of audio cables (two single audio cables for mono VCRs)
- two video cables

Stereo VCR [Playback]

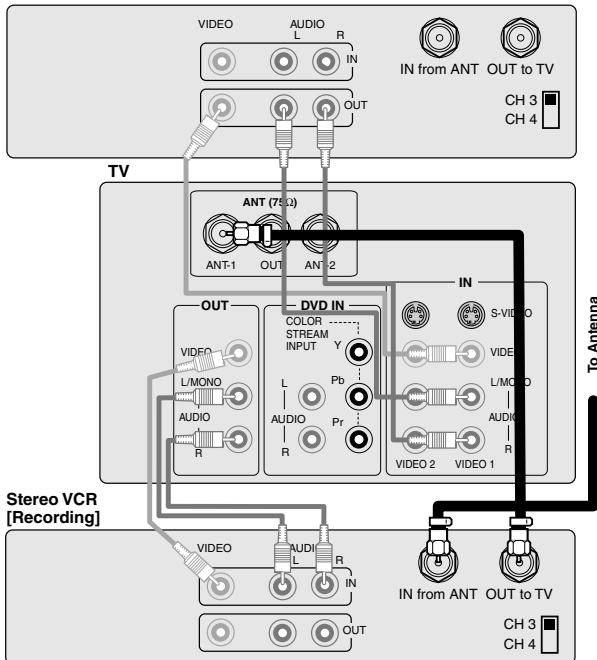

### Note:

When recording, set Audio Out to FIX (see "Selecting variable audio OUT" on page 35). With Audio Out set to FIX, the TV's volume setting during recording will not affect the sound level being recorded.

### Caution:

The unauthorized recording of television programs, videotapes, DVDs, and other materials may infringe upon the provisions of copyright laws.

### Note:

If you have S-VHS VCRs, use S-video cables instead of regular video cables.

Do not connect a regular video cable and an S-video cable to Video-1 (or Video-2) at the same time.

Do not connect the same VCR to the output and input jacks on the TV at the same time.

## Connecting a camcorder

This connection allows you to watch videos recorded on a camcorder.

### You will need:

- one pair of audio cables
- one video cable

### Note:

If your camcorder has an S-video connection, an S-video cable will provide better picture performance than a regular video cable.

Do not connect a regular video cable and an S-video cable to Video-1 (or Video-2) at the same time.

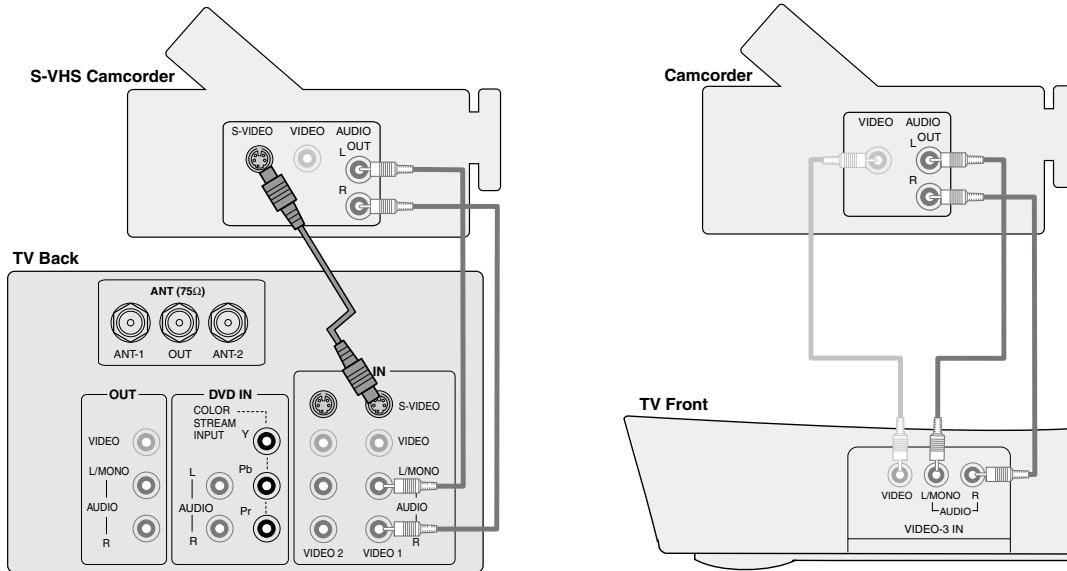

## Connecting an audio amplifier

This connection allows you to use an audio amplifier to adjust the audio level. This connection also allows you to use external speakers.

### You will need:

- one pair of audio cables

### Note:

To control the audio, both the TV and the amplifier must be turned on, and the volume of both must be set above 0, or you will not hear any sound. See "Selecting variable audio OUT" on page 35 for additional details.

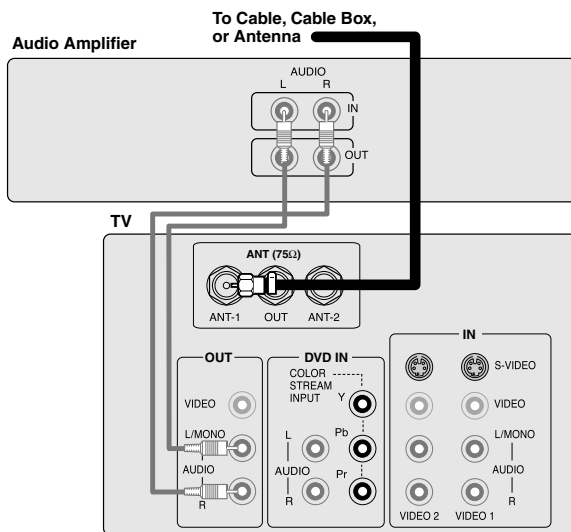

# Using the remote control

## Preparing the remote control for use

The remote control will operate your TV, most VCR models, and most cable TV converters together, even if they are different brands.

- If you will be using your TV with a Toshiba VCR or cable TV converter, your remote control is already programmed and ready to use. See “Using the remote control with a Toshiba VCR or cable TV converter” below.
- If you own a non-Toshiba VCR or converter and want to use your TV remote control to operate it, you will need to program the remote control. See “Programming the remote control for use with a non-Toshiba VCR or cable TV converter” on page 13.

## Installing the remote control batteries

### To install the batteries:

1. Slide the battery cover off the back of the remote control.

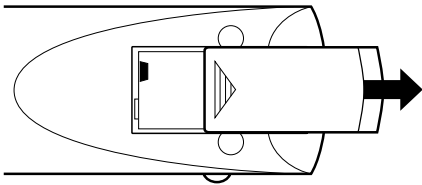

2. Install two “AA” size batteries. Match the + and – symbols on the batteries to the symbols on the battery compartment.

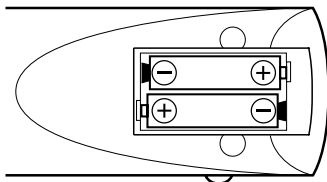

3. Slide the battery cover back onto the remote control until the lock snaps.

## Using the remote control with a Toshiba VCR or cable TV converter

### To control a Toshiba VCR:

Set the TV/CABLE/VCR switch to the VCR position. The shaded buttons in the illustration at right will then control the VCR. The unshaded buttons will operate the TV as usual.

### To control a Toshiba cable TV converter:

Set the TV/CABLE/VCR switch to the CABLE position. The shaded buttons in the top portion of the illustration at right will then control the cable TV converter.

### Note:

The remote control provided with your TV may or may not operate certain features on your VCR, cable TV converter, or other electronic equipment. Refer to the owner's manuals provided with your other equipment to see which features are available. In addition, the other remote controls may have buttons not available on your TV's remote control. If you would like to use those features or buttons, you may need to use the original remote controls provided with your other equipment.

### Caution:

- Dispose of batteries in a designated disposal area. Do not throw batteries into a fire.
- Do not mix battery types or combine used batteries with new ones.
- Remove dead batteries immediately to prevent battery acid from leaking into the battery compartment.
- If you do not intend to use the remote control for a long time, remove the batteries.

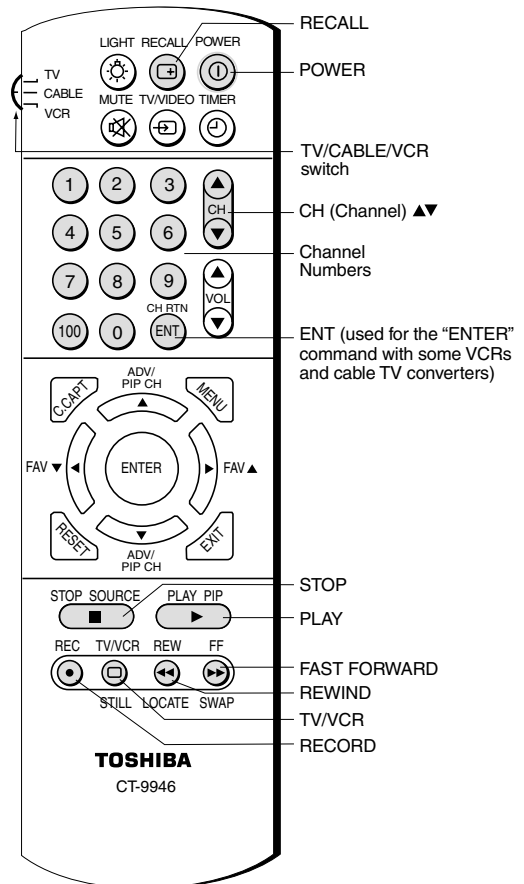

## Programming the remote control for use with a non-Toshiba VCR or cable TV converter

The remote control provided with your Toshiba TV is preprogrammed to operate Toshiba VCRs and cable TV converters.

### To operate a non-Toshiba VCR or converter using the remote control provided with your TV:

1. Refer to the VCR and cable TV converter code tables (below and on the next page) to find the corresponding code for your VCR or converter brand.  
If more than one code is listed, try each one separately until you find the one that works.
2. If you are programming the remote control to operate your:
  - **VCR:** Set the TV/CABLE/VCR switch on the remote control to "VCR."
  - **Cable TV converter:** Set the TV/CABLE/VCR switch on the remote control to "CABLE."
3. While holding down **RECALL**, press the **CHANNEL NUMBERS** to enter the three-digit code for your VCR or cable TV converter brand.
4. Point the remote control at the VCR or converter, and press **POWER** to test the code.
  - If the VCR or converter responds, you entered the correct code.
  - If the VCR or converter does not respond, repeat steps 1–4 using another code.
5. Set the TV/CABLE/VCR switch to "TV" to control the TV.

For future reference, write down the codes you used:

VCR code: \_\_\_\_\_

Cable TV converter code: \_\_\_\_\_

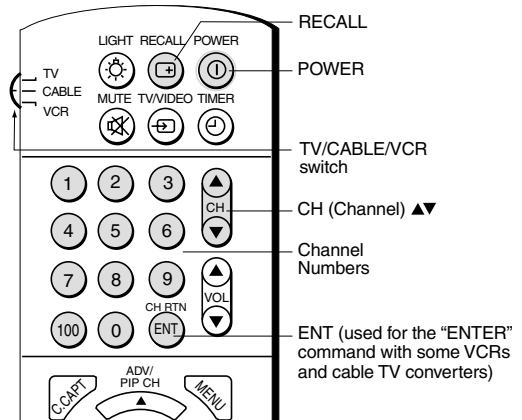

#### Note:

- Every time you replace the batteries, you must reprogram the remote control.
- Some newer VCRs are capable of working on either of two remote codes. These VCRs have a switch labeled "VCR1/VCR2." If your VCR has this kind of switch and does not respond to any of the codes for your VCR brand, set the switch to the other position (VCR1 or VCR2) and reprogram the remote control.

### VCR code table

Brand	Code	Brand	Code	Brand	Code
Adventura	019	CCE	091, 297	Fisher	066, 073, 085, 123
Aiko	297	Citizen	056, 297	Fuji	052, 054
Aiwa	019	Colt	091	Funai	019, 344
Akai	060, 068, 080, 125, 261	Craig	056, 066, 091, 259	Garrard	019, 344
American High	054	Curtis Mathes	054, 060, 079	GE	054, 079, 084, 221
Asha	259	Cybernex	259	Go Video	251, 298
Audiovox	056	Daewoo	039, 064, 297	Goldstar	037, 056, 057
Beaumark	259	Daytron	039	Gradiente	019
Bell & Howell	123	Dynatech	019	Harley Davidson	019
Brandt	206	Electrohome	056	Harman/Kardon	057, 094
Broksonic	140, 203, 230, 314, 380	Electrohome	056	Harwood	087, 091
Calix	056	Emerex	051	Headquarter	065
Canon	054	Emerson	019, 021, 056, 062, 080, 087, 140, 203, 227, 228, 230, 231, 297, 313, 314, 380, 498	HI-Q	066
Capehart	039			Hitachi	060, 061, 084, 124, 185, 254
Carver	100			Jensen	060
				JVC	027, 060, 086
				Kenwood	057, 060, 086

**VCR code table (cont.)**

<b>Brand</b>	<b>Code</b>	<b>Brand</b>	<b>Code</b>	<b>Brand</b>	<b>Code</b>	
KLH	091	Sanky	058, 067	Garrard	172	
Kodak	054, 056	Sansui	060, 086	CG Electronics	075	
Lloyd	019, 227	Sanyo	065, 066, 123, 259	Gemini	034, 089	
Logik	091	Scott	062, 064, 140, 203, 229, 230, 231	General Instrument	030, 295	
LXI	056	Sears	054, 056, 061, 065, 066, 073, 085, 123, 124	Gold Star	059, 163	
Magnavox	054, 058, 100, 129, 168	Sharp	067, 081	Hamlin	028, 039, 053, 278, 292	
Magnin	259	Shintom	091	Hitachi	030	
Marantz	054, 100	Shogun	259	Hytex	026	
Marta	056	Singer	091	Jasco	172	
Matsushita	054	Sony	051, 052, 053, 054	Jerrold	022, 030, 031, 033, 034, 066, 295	
MEI	054	STS	061	Macom	052	
Memorex	019, 054, 056, 058, 065, 066, 067, 123, 259	Sylvania	019, 054, 062, 100, 129	Magnavox	046	
MGA	062, 080	Symphonic	019, 344	Memorex	019	
MGN Technology	259	Tatung	060	Movietime	175	
Minolta	061, 124	Teac	019, 060	NSC	089, 175	
Mitsubishi	062, 080, 086, 094, 192, 233, 261	Technics	054, 181	Oak	026, 038, 267	
Motorola	054, 067	Teknika	019, 054, 056, 071	Panasonic	019, 040, 126	
MTC	019, 259	Telefunken	206	Paragon	019	
Multitech	019, 091	TMK	227, 259	Philips	044, 046, 047, 048, 049, 050, 172	
NAD	077	Toshiba	062, 064, 085, 229, 231, 385	Pioneer	042, 163, 552	
NEC	057, 059, 060, 069, 086	Totevision	056, 259	Popular Mechanics	419	
Nikko	056	Unitech	259	Pulsar	019	
Noblex	259	Vector	064	RCA	040	
Olympus	054	Vector Research	057, 059	Regal	039, 278, 292	
Optimus	056, 067, 077, 123	Video Concepts	059, 064, 080	Recoton	419	
Optonica	081	Videosonic	259	Regency	021	
Orion	498	Wards	019, 054, 061, 066, 067, 081, 091, 168, 231, 259	Rembrandt	030, 089	
Panasonic	054, 096, 181, 244, 473	XR-1000	019, 054, 091	Runco	019	
Penney	054, 056, 057, 059, 061, 073, 259	Yamaha	057	Samsung	059, 163	
Pentax	061, 084, 124	Zenith	052, 053, 058	Scientific Atlanta	025, 027, 036, 296	
Philco	054	<b>Cable TV converter code table</b>			Signal	034, 059
Philips	054, 081, 100, 129	<b>Brand</b>	<b>Code</b>	Signature	030	
Pilot	056	ABC	020, 022, 027, 030, 032, 033, 036, 066	SL Marx	059	
Pioneer	077, 086	Antronix	041	Sprucer	040	
Portland	039	Archer	041, 058, 172	Standard		
Protec	091	Belcor	075	Components	174	
Pulsar	058	Cable Star	075	Starcom	022, 034, 066	
Quarter	065	Cabletenna	041	Stargate	034, 059	
Quartz	065	Cableview	041	Starquest	034	
Quasar	054, 096	Century	172	Sylvania	020	
Radio Shack	019, 056, 344	Citizen	172	Televue	059	
Radix	056	Colour Voice	044, 050	Texscan	020	
Randex	056	Comtronics	059, 079	Tocom	031, 032, 078	
RCA	061, 079, 084, 096, 124, 125, 168, 221	Contec	038	Toshiba	019	
Realistic	019, 054, 056, 065, 066, 067, 081, 085, 123, 259	Dae Ryung	027	Tusa	034	
Ricoh	053	Eastern	021	Unika	041, 172	
Runco	058	Focus	419	United Artists	026	
Samsung	064, 259			United Cable	022	
				Universal	041, 058, 075, 096, 172, 210	
				Viewstar	046, 079, 230	
				Zenith	019	
				Zentek	419	

## Learning about the remote control

**LIGHT** illuminates the keys

**RECALL** displays on-screen information (pages 21, 22)

**TV/CABLE/VCR switch** switches among TV, Cable, and VCR inputs (page 12)

**POWER** turns the TV on and off

**MUTE** turns off the sound (page 33)

**TIMER** sets the TV to turn off at a specific time (page 31)

**TV/VIDEO** selects the signal input source (page 17)

**Channel ▲▼** cycles through programmed channels (page 17)

**Channel Numbers (0–9, 100)** directly tune channels (page 18)

**VOL ▲▼** adjusts the volume level

**CH RTN** (Channel Return) returns to the last viewed channel (page 19)

**C.CAPT** opens the Closed Caption menu (page 32)

**MENU** accesses on-screen menus (page 16)

**▲▼ ◀▶ (Up/Down/Left/Right Arrows)** select or adjust menu items when a menu is on-screen (page 17)

**FAV ▼▲ (Left/Right Arrows)** select channels you programmed as favorite channels (page 19)

**EXIT** sets menu information and closes menus (page 23)

**PIP Buttons** access PIP functions when the TV/Cable/VCR switch is set to TV (pages 28, 29)

**PIP** turns the PIP and Multi-Window feature on and off (one press for 1/9-size PIP window; two presses for 1/16-size PIP window; three presses for the Multi-Window feature)

**SOURCE** selects the PIP signal input source

**PIP CH ▲▼ (Up/Down Arrows)** select PIP channels (when PIP is on-screen)

**STILL** freezes the PIP display

**LOCATE** changes the location of the PIP window

**SWAP** switches the main and PIP pictures

**Note:** When the **TV/Cable/VCR switch** is set to "VCR," the PIP buttons function instead as VCR buttons (STOP, PLAY, REC, TV/VCR, REW, FF; see page 12).

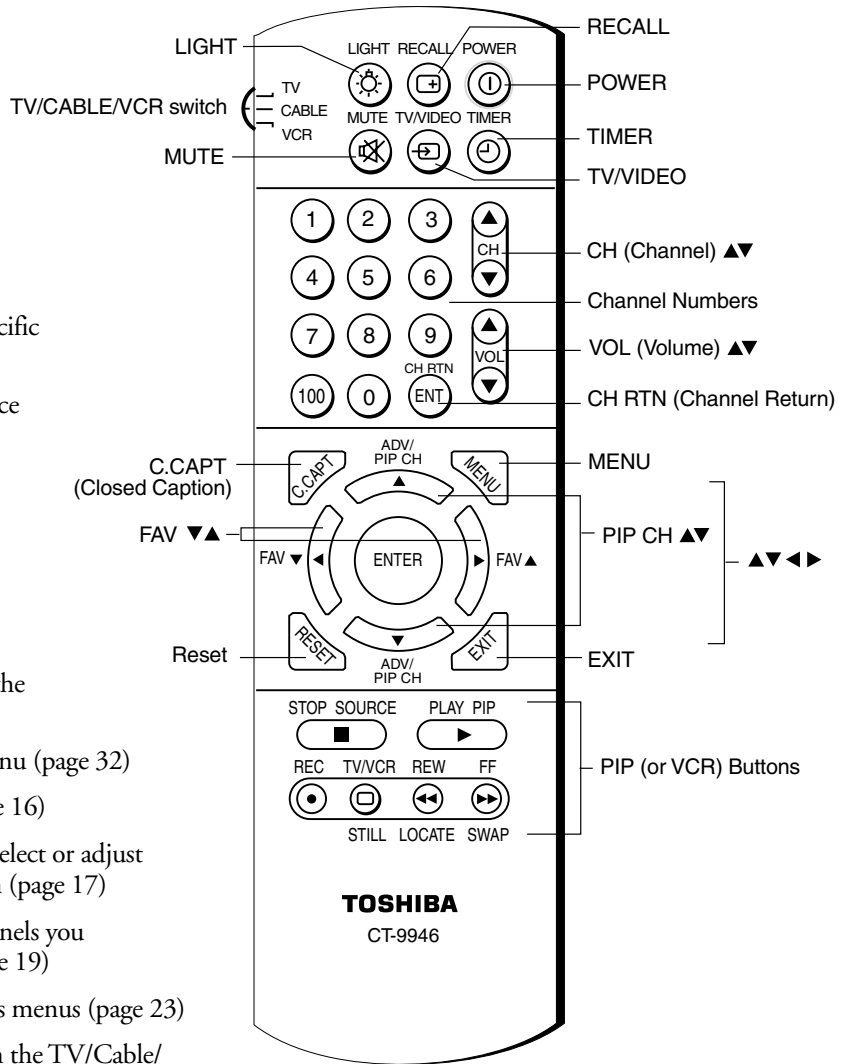

## Setting up your TV

After installing the batteries and programming the remote control, you will need to set some preferences on your TV using the menu system. You can access the menus using the buttons on your TV or remote control.

- When you make a menu selection, your changes occur immediately. You do not have to press **MENU** or **EXIT** to save your changes.  
**Note:** The TV front panel does not have an **EXIT** button.
- When you are finished programming the menus, you can press **EXIT** to clear the on-screen display, or wait 15 seconds and the on-screen display will disappear automatically. Your changes are automatically saved either way.

TV Front Panel

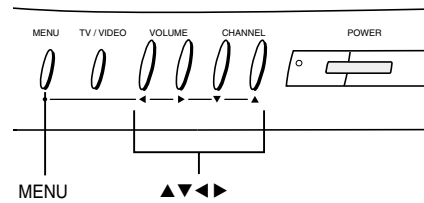

## Changing the on-screen display language

You can choose from three different languages (English, French, or Spanish) for the on-screen display of menus and messages.

**To select an on-screen display language:**

1. Press **MENU**.
2. Press ◀ or ▶ until the SET UP menu appears.
3. Press ▲ or ▼ to highlight LANGUAGE.
4. Press ◀ or ▶ to highlight your desired language.

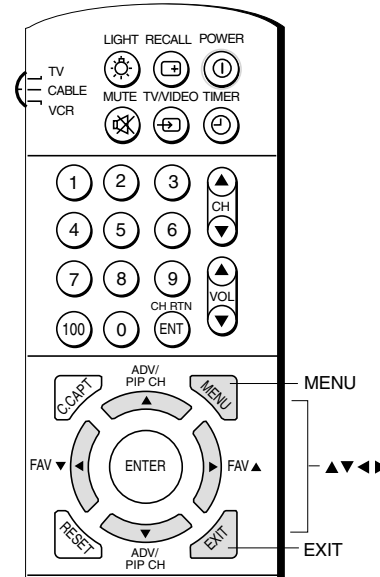
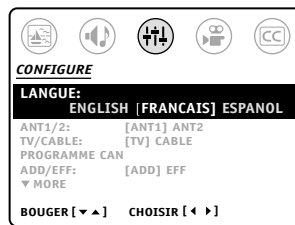
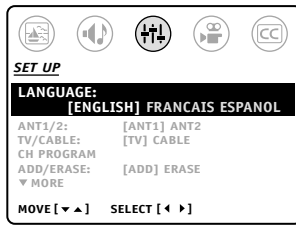

## Selecting the antenna input

You can connect to one of two different antenna input sources (ANT 1 or ANT 2).

**To select the antenna input:**

1. Press **MENU**.
2. Press ◀ or ▶ to highlight the SET UP menu.
3. Press ▲ or ▼ to highlight ANT 1/2.
4. Press ◀ or ▶ to highlight either ANT 1 or ANT 2, depending on the antenna terminal you wish to use.

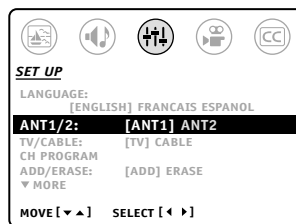



## Selecting the signal source

Use the **TV/VIDEO** button on the remote control or TV to monitor or change the signal source connected to your TV.

### To monitor the signal source:

Press **TV/VIDEO** once. The current signal source displays in green.

### To change the signal source:

Repeatedly press **TV/VIDEO** to select either VIDEO 1, VIDEO 2, VIDEO 3, ColorStream, ANT 1, or ANT 2. The selected signal source displays in green.

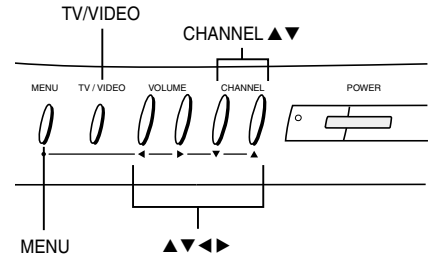
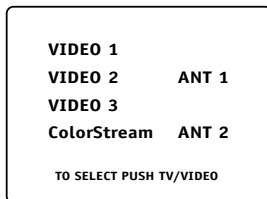

## Watching video input

### To view a signal from other devices connected to your TV (such as a VCR or DVD player):

Repeatedly press **TV/VIDEO** on the remote control or TV to select either VIDEO 1, VIDEO 2, VIDEO 3, or ColorStream. (For device connection information, see "Connecting your TV" on page 7).

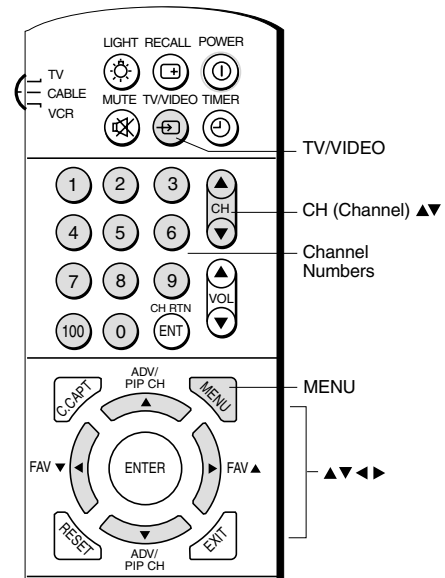

## Programming channels into the TV's memory

When you press **CHANNEL ▲▼** on the TV or remote control, the TV stops only on the channels stored in the TV's memory.

**Note:** To tune the TV to a channel not programmed into the memory, use the **CHANNEL NUMBERS** on the remote control.

Follow the steps below and on the next page to program channels into the TV's memory.

### Programming channels automatically

Your TV can automatically detect all active channels in your area and store them in the TV's memory. After the channels are stored automatically, you can manually add or erase individual channels (see page 18). If you use both ANT-1 and ANT-2 terminals, you will need to program channels for each signal source.

#### To program channels automatically:

1. Press **MENU**.
2. Press **◀** or **▶** to highlight the SET UP menu.
3. Press **▲** or **▼** to highlight TV/CABLE.
4. Press **◀** or **▶** to highlight TV (if you use an antenna) or CABLE (if you use cable).
5. Press **▼** to highlight CH PROGRAM.

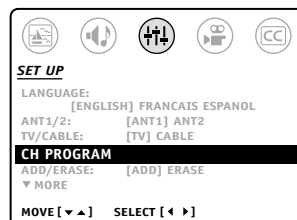
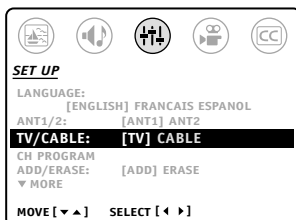

(Continued on next page)

- Press ◀ or ▶ to start automatic channel programming (“CH PROGRAM” displays on-screen). The TV automatically cycles through every TV or cable channel (depending on which you selected), and stores all active channels in the TV’s memory.
- When automatic channel programming is complete, the message “CH Programming Completed” appears.
- Press **CHANNEL ▲▼** to view the programmed channels.

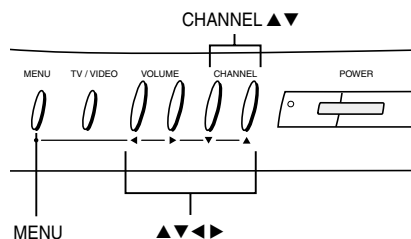

### Adding and erasing channels manually

After you have automatically programmed the channels into the TV’s memory, you can manually add and erase individual channels.

#### To add a channel to or erase a channel from the TV’s memory:

- Tune the TV to the channel you want to add or erase. If you are adding a channel, you will need to use the **CHANNEL NUMBERS** to select the channel.
- Press **MENU**.
- Press ◀ or ▶ to highlight the SET UP menu.
- Press ▲ or ▼ to highlight ADD/ERASE.

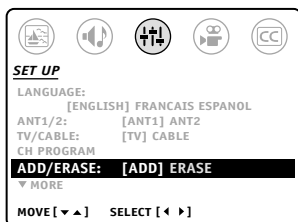

- Press ◀ or ▶ to highlight ADD or ERASE, whichever function you want to perform.
- Press **MENU**.
- Repeat steps 1–6 for other channels you want to add or erase, or press **EXIT** to return to normal TV viewing.

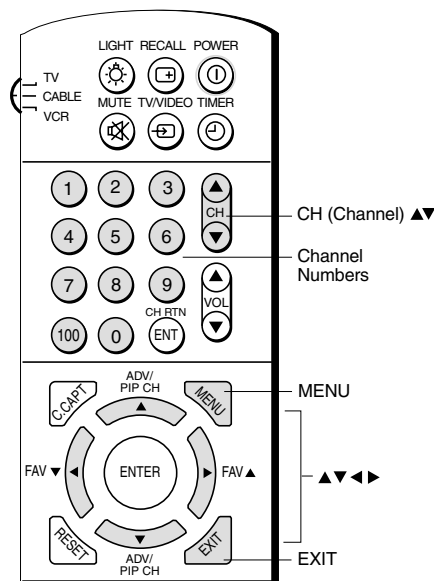

### Changing channels

#### To change to the next programmed channel:

Press **CHANNEL ▲▼**.

#### To change to a specific channel (programmed or unprogrammed):

Press the **CHANNEL NUMBERS** (0–9 and 100).

**Note:** For channels 100 and higher, press the 100 button, and then the next two channel numbers (for example, to select channel 100, press 100, 0, 0; to select channel 125, press 100, 2, 5).

# Using the TV's features

## Adjusting the channel settings

### Switching between two channels

You can switch between two channels without entering an actual channel number each time.

#### To switch between two channels:

1. Select the first channel you want to view.
2. Select a second channel using the **CHANNEL NUMBERS** (0–9 and 100).
3. Press **CH RTN** (channel return). The previous channel will display.

Every time you press **CH RTN**, the TV will switch back and forth between the last two channels you tuned the TV to.

### Programming your favorite channels

The Favorite Channel feature allows you to use the **FAV**  $\blacktriangledown$ / $\blacktriangle$  buttons on the remote control to cycle through your favorite channels, skipping over channels you do not normally watch. You can program a maximum of 12 favorite channels.

**Note:** You can still use **CHANNEL**  $\blacktriangle$ / $\blacktriangledown$  to cycle through all the channels you previously programmed into the TV's memory (see "Adding channels to the TV's memory" on page 17).

#### To program your favorite channels:

1. Tune the TV to a channel you want to program as a favorite channel.
2. Press **MENU**.
3. Press  $\blacktriangleleft$  or  $\blacktriangleright$  to highlight the SET UP menu.
4. Press  $\blacktriangle$  or  $\blacktriangledown$  to highlight FAVORITE CH.

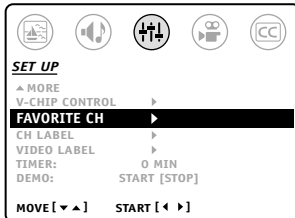

5. Press  $\blacktriangleleft$  or  $\blacktriangleright$  to display the FAVORITE CH menu. SET/CLEAR will be highlighted.
6. Press  $\blacktriangleleft$  or  $\blacktriangleright$  to highlight SET.
7. Press  $\blacktriangledown$  to add the current channel to the list.
8. Press **MENU**.

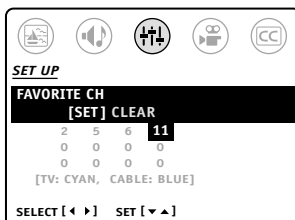

9. Repeat steps 1–8 for up to 12 channels, or press **EXIT** to close the menu.

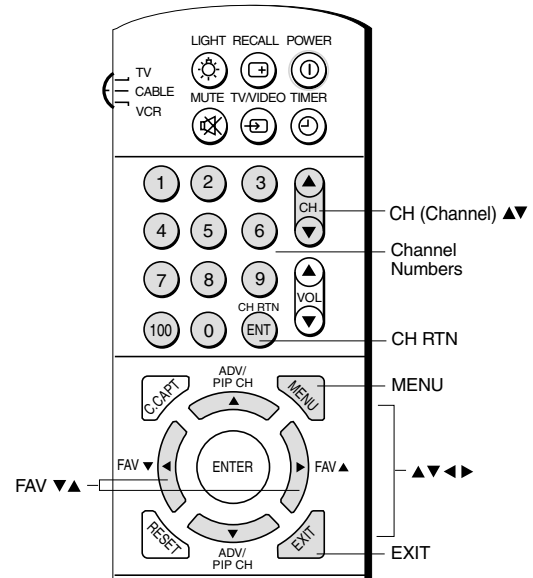

### To select your favorite channels:

Press **FAV**  $\blacktriangledown$  $\blacktriangle$  on the remote control to cycle through the favorite channels you programmed.

**Note:** The **FAV**  $\blacktriangledown$  $\blacktriangle$  buttons will not work unless you program at least one favorite channel.

### To clear a favorite channel:

1. Tune the TV to the channel you want to clear from your favorite channel list.
2. Press **MENU**.
3. Press  $\blacktriangleleft$  or  $\blacktriangleright$  to highlight the SET UP menu.
4. Press  $\blacktriangle$  or  $\blacktriangledown$  to highlight FAVORITE CH.
5. Press  $\blacktriangleleft$  or  $\blacktriangleright$  to display the FAVORITE CH menu. SET/CLEAR will be highlighted.
6. Press  $\blacktriangleleft$  or  $\blacktriangleright$  to highlight CLEAR.

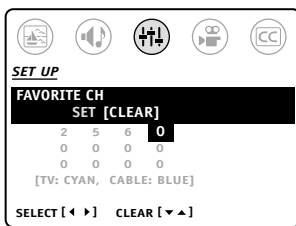

7. Press  $\blacktriangledown$  to clear the current channel number from the list.
8. Press **MENU**.
10. Repeat steps 1–8 for other channels you want to clear from your favorite channel list, or press **EXIT** to close the menu.

### Note:

The **FAV**  $\blacktriangledown$  $\blacktriangle$  buttons function as menu  $\blacktriangleleft$  $\blacktriangleright$  buttons when a menu is on-screen.

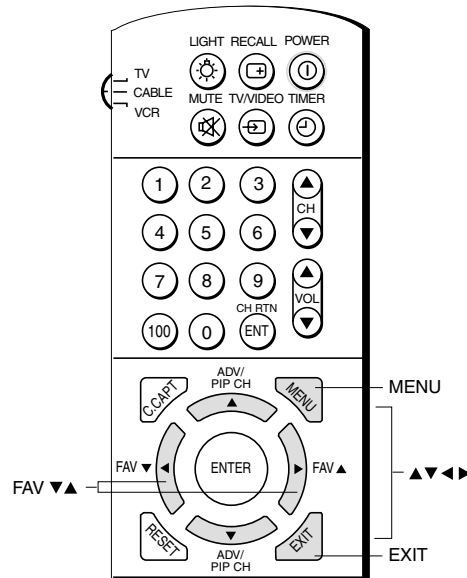

## Using the V-Chip Control (blocking) feature

You can use the V-Chip Control feature to block certain programs or channels, to prevent others from viewing them.

### Selecting a PIN code

Before you can block programs or channels, you must select a personal identification number (PIN) code. Your PIN code allows you to access the V-Chip Control menu, and prevents others from changing the rating and blocking limits you set.

### To select your PIN code and access the V-Chip Control menu:

1. Press **MENU**.
2. Press  $\blacktriangleleft$  or  $\blacktriangleright$  to highlight the SET UP menu.
3. Press  $\blacktriangle$  or  $\blacktriangledown$  to highlight V-CHIP CONTROL.
4. Press  $\blacktriangleleft$  or  $\blacktriangleright$  to display the “Enter PIN Code” screen.

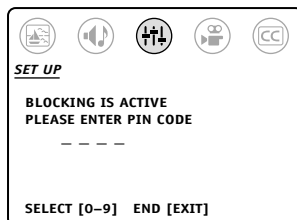
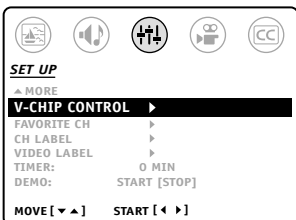

- Use the **CHANNEL NUMBERS** (0–9) to enter your four-digit PIN code. After the code is entered, the V-Chip Control menu appears.

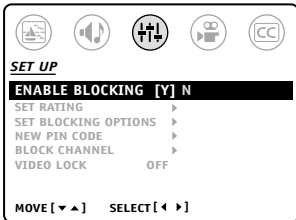

V-Chip Control (Blocking) Menu

- Press **▲** or **▼** to highlight **ENABLE BLOCKING**.
- Press **◀** or **▶** to highlight **“Y,”** which enables all blocking by activating the V-Chip. See “Blocking programs by ratings” on page 22, “Blocking unrated movies or programs” on page 23, and “Blocking channels” on page 24.  
(**Note:** Highlight **“N”** to deactivate the V-Chip Control feature and disable blocking.)

### Changing your PIN code

- Press **MENU**.
- Press **◀** or **▶** to highlight the **SET UP** menu.
- Press **▲** or **▼** to highlight **V-CHIP CONTROL**.
- Press **◀** or **▶** to display the Enter PIN Code screen.
- Use the Channel Number buttons (0–9) to enter your existing PIN code. After the code is entered, the V-Chip Control menu appears.
- Press **▲** or **▼** to highlight **NEW PIN CODE**.
- Press **◀** or **▶** to display the New PIN Code screen.

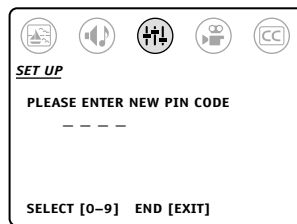
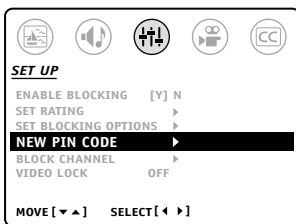

- Use the **CHANNEL NUMBERS** (0–9) to enter a new PIN code. After the new code is entered, the V-Chip Control menu appears.
- Press **EXIT** to return to normal TV viewing.

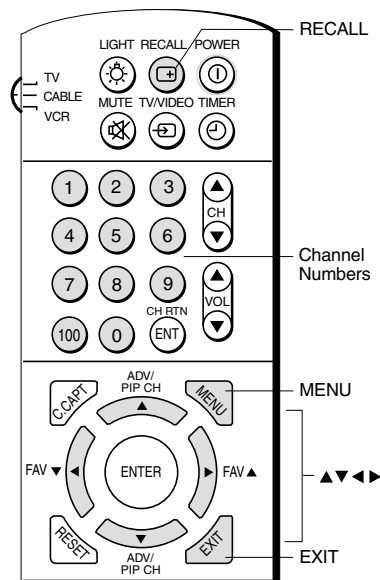

#### **Note:**

*If you forget your PIN code:*

- Follow steps 1–4 under “Changing your PIN code” at left.
- Then press **RECALL** four times within five seconds.

*This allows you to proceed to the V-Chip Control menu and reset your PIN code.*

## Blocking programs by ratings

The Motion Picture Association of America (MPAA) uses a rating system to qualify motion picture content. Television broadcasters employ a similar rating system to qualify the content of television programs. The MPAA, Youth TV, and TV ratings work with the V-Chip feature to allow you to block access to programs that exceed the rating limits you set.

### Note:

Press **RECALL** to see the rating of the program you are viewing. Not all programs are rated, however. To block programs or movies that are not rated, see "Blocking unrated movies and programs" on page 23.

Ratings definitions	
<p><b>MPAA Ratings</b></p> <p>X For adults only.</p> <p>NC17 Not intended for anyone 17 or under.</p> <p>R Restricted. Under 17 requires an accompanying parent or adult guardian.</p> <p>PG13 Parents strongly cautioned. Some material may not be appropriate for children under 13.</p> <p>PG Parental guidance suggested. Some material may not be appropriate for children.</p> <p>G General audience. Appropriate for all ages.</p> <p><b>Youth TV Ratings</b></p> <p>Y7, Y7FV Directed to older children. Programs rated Y7 are designed for children 7 and above. Programs rated Y7FV contain fantasy violence that may be more intense or combative than Y7-rated programs.</p> <p>Y For all children. Programs rated Y are designed to be appropriate for all children.</p>	<p><b>TV Ratings</b></p> <p>MA Mature audience only. This program is specifically designed to be viewed by adults and therefore may be unsuitable for children under 17.</p> <p>Dialog Intensely suggestive dialog</p> <p>Language Crude or indecent language</p> <p>Sex Explicit sexual activity</p> <p>Violence Graphic violence</p> <p>14 Parents strongly cautioned. This program contains some material that many parents would find unsuitable for children under 14 years of age.</p> <p>Dialog Frequent suggestive dialog</p> <p>Language Frequent coarse language</p> <p>Sex Intense sexual situations</p> <p>Violence Intense violence</p> <p>PG Parental guidance suggested. This program contains material that parents may find unsuitable for younger children.</p> <p>Dialog Some suggestive dialog</p> <p>Language Occasional coarse language</p> <p>Sex Some sexual situations</p> <p>Violence Moderate violence</p> <p>G General audience. Most parents would find this program suitable for all ages.</p> <p>No DLSV Programs without any Dialog, Language, Sex, or Violence ratings.</p>

### To block programs by rating:

1. Press **MENU**.
2. Press ◀ or ▶ to highlight the SET UP menu.
3. Press ▲ or ▼ to highlight V-CHIP CONTROL.
4. Press ◀ or ▶ to display the "Enter PIN Code" screen.
5. Use the **CHANNEL NUMBERS** (0–9) to enter your four-digit PIN code. After the code is entered, the V-Chip Control menu appears.
6. Press ▲ or ▼ to highlight ENABLE BLOCKING.
7. Press ◀ or ▶ to highlight "Y," which enables all blocking by activating the V-Chip. (**Note:** Highlight "N" to deactivate the V-Chip Control feature and disable blocking.)

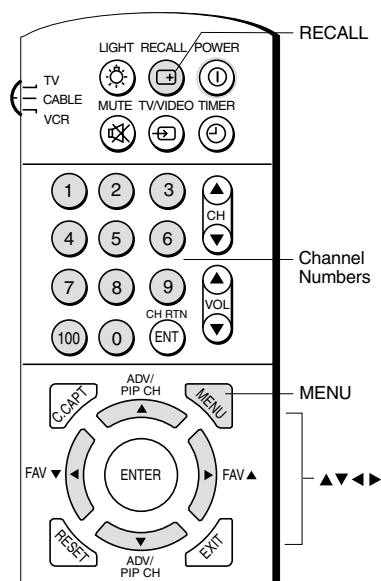
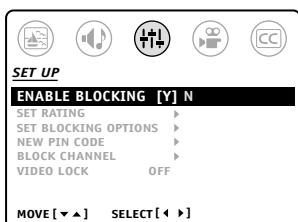

8. Press ▲ or ▼ to highlight SET RATING.
9. Press ◀ or ▶ to display the Set Rating menu.
10. Press ▲ or ▼ to highlight MPAA Rating, Youth TV Rating, or TV Rating.
11. Press ▶ to select (or ◀ to deselect) the ratings to be blocked. Blocked ratings will be marked with “X”; unblocked ratings will be marked with “✓.” All ratings higher than the ones that are selected (“X”) are blocked as well. For example, if you block the MPAA rating R, programs with the higher ratings NC17 and X will also be blocked.

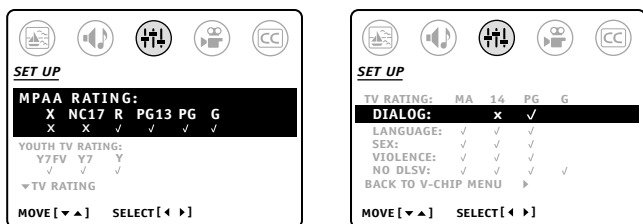

12. When you finish selecting the program ratings to be blocked:
  - To return to the V-Chip menu, press ▲ or ▼ to highlight BACK TO V-CHIP MENU, and then press ◀ or ▶.
  - To return to normal TV viewing, press **EXIT**.

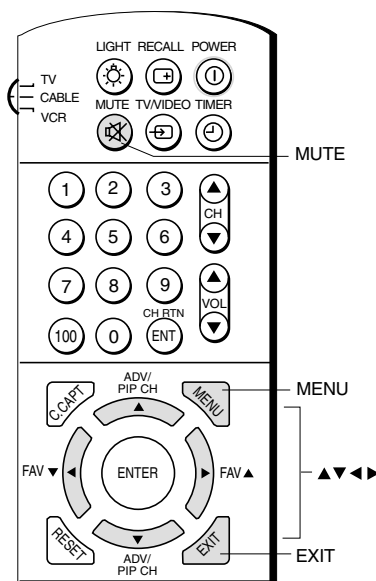

### Unblocking programs temporarily

When you try to view a program with a ratings block, a message appears stating that the program has been blocked because the program's rating exceeds the set limits. To temporarily override the block and view the program, press **MUTE** and enter your PIN code. To reset your original ratings blocks, turn the TV off and then on again.

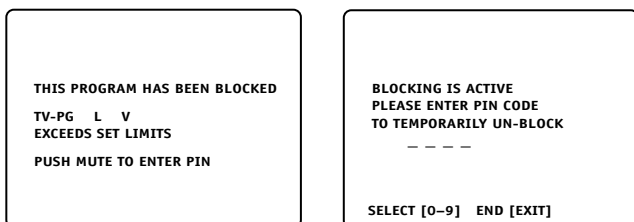

### Blocking unrated movies and programs

Some movies and programs are not rated. You can use the V-Chip Control feature to block unrated movies and programs.

#### To block unrated movies and programs:

1. Press **MENU**.
2. Press ◀ or ▶ to highlight the SET UP menu.
3. Press ▲ or ▼ to highlight V-CHIP CONTROL.
4. Press ◀ or ▶ to display the Enter PIN Code screen.
5. Use the **CHANNEL NUMBERS** (0–9) to enter your four-digit PIN code. After entering the code, the V-Chip Control menu appears.
6. Press ▲ or ▼ to highlight ENABLE BLOCKING.

*(Continued on next page)*

- Press ◀ or ▶ to highlight “Y,” which enables all blocking by activating the V-Chip. (**Note:** Highlight “N” to deactivate the V-Chip feature and disable blocking.)
- Press ▲ or ▼ to highlight SET BLOCKING OPTIONS.
- Press ◀ or ▶ to display the unrated movie/program blocking menu.
- Press ▲ or ▼ to highlight BLOCK TV NONE RATING.
- Press ◀ or ▶ to highlight “Y” to block movies/programs rated “TV None.” (**Note:** Highlight “N” to unblock unrated programs.)
- Press **EXIT** to return to normal TV viewing.

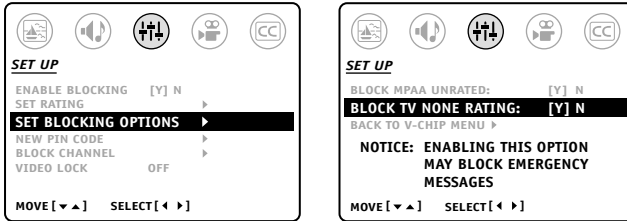

**Caution:**

Blocking unrated television programs (those rated “TV NONE”) may block emergency messages.

**Blocking channels**

You can block a maximum of four TV channels and four cable channels. Blocked channels cannot be viewed, regardless of their ratings. If you try to tune the TV to a blocked channel, the nearest unblocked channel will display.

**To block a channel:**

- Tune the TV to the channel you want to block.
- Press **MENU**.
- Press ◀ or ▶ to highlight the SET UP menu.
- Press ▲ or ▼ to highlight V-CHIP CONTROL.
- Press ◀ or ▶ to display the Enter PIN Code screen.
- Use the **CHANNEL NUMBERS** (0–9) to enter your four-digit PIN code. After entering the code, the V-Chip Control menu appears.
- Press ▲ or ▼ to highlight ENABLE BLOCKING.
- Press ◀ or ▶ to highlight “Y,” which enables all blocking by activating the V-Chip Control feature. (**Note:** Highlight “N” to deactivate the V-Chip feature and disable blocking.)
- Press ▲ or ▼ to highlight BLOCK CHANNEL.
- Press ◀ or ▶ to display the BLOCK CHANNEL menu. SET/CLEAR will be highlighted.
- Press ◀ or ▶ to highlight SET.
- Press ▼ to add the current channel to the list.

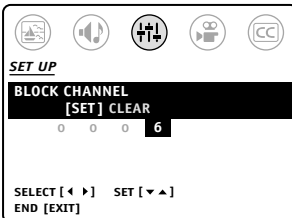

- Press **MENU**.
- Press **EXIT**.
- Repeat steps 1–14 to block additional channels.

**Note:**

After programming CHANNEL BLOCK, tune the TV to a channel that is not blocked before turning the TV off.

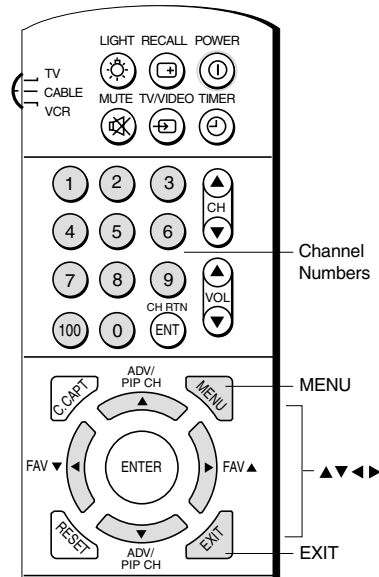



### To unblock all blocked channels:

**Note:** This will unblock every channel you have blocked. You cannot unblock individual channels.

1. Press **MENU**.
2. Press ◀ or ▶ to highlight the SET UP menu.
3. Press ▲ or ▼ to highlight V-CHIP CONTROL.
4. Press ◀ or ▶ to display the Enter PIN Code screen.
5. Use the **CHANNEL NUMBERS** (0–9) to enter your four-digit PIN code. After entering the code, the V-Chip Control menu appears.
6. Press ▲ or ▼ to highlight BLOCK CHANNEL.
7. Press ◀ or ▶ to display the BLOCK CHANNEL menu. SET/CLEAR will be highlighted.
8. Press ◀ or ▶ to highlight CLEAR.
9. Press ▼ to clear all blocked channels from the list.
10. Press **MENU**.
11. Press **EXIT** to return to normal TV viewing.

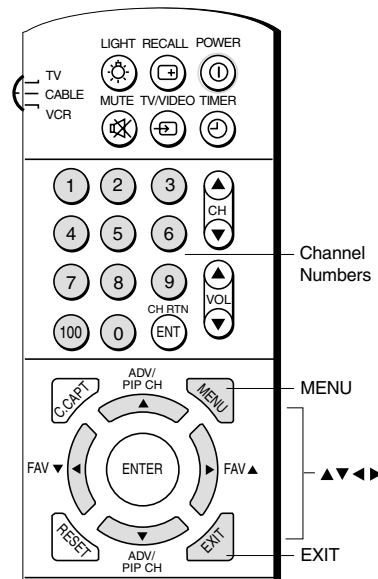

### Locking video inputs

You can use the Video Lock feature to block the input sources (Video 1, Video 2, Video 3, and ColorStream) and channels 3 and 4.

**Note:** The Video Lock feature is independent of the Enable Blocking option of V-Chip control (page 21).

#### The Video Lock options are:

- Video: Blocks Video 1, Video 2, Video 3, and ColorStream.
- Video+: Blocks Video 1, Video 2, Video 3, ColorStream, and channels 3 and 4.
- Off: Disables the Video Lock feature.

#### To set up video lock:

1. Press **MENU**.
2. Press ◀ or ▶ to highlight the SET UP menu.
3. Press ▲ or ▼ to highlight V-CHIP CONTROL.
4. Press ◀ or ▶ to display the Enter PIN Code screen.
5. Use the **CHANNEL NUMBERS** (0–9) to enter your four-digit PIN code. After entering the code, the V-Chip Control menu appears.
6. Press ▲ or ▼ to highlight VIDEO LOCK.
7. Press ◀ or ▶ to select the desired level of video locking (Video, Video+, or Off).

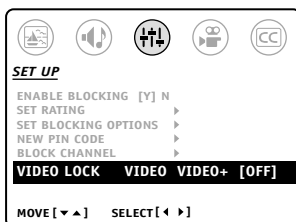

8. Press **EXIT** to return to normal TV viewing.

#### **Note:**

*In normal TV viewing, if you cannot access the input sources (Video 1, Video 2, Video 3, and ColorStream) or channels 3 and 4, check the Video Lock setting and highlight OFF if necessary.*

## Channel labels

You can assign labels to a maximum of 32 channels. Each channel label can have a maximum of four characters.

For example, if channel 8 is your public television station, you could create the label “PBS” for that channel. The label “PBS” would then appear on-screen when you tune the TV to channel 8.

Channel labels appear on-screen above the channel number every time you turn the TV on, change the channel, or press **RECALL**.

### To create a channel label:

1. Tune the TV to the channel you want to label.
2. Press **MENU**.
3. Press ◀ or ▶ to highlight the SET UP menu.
4. Press ▲ or ▼ to highlight CH LABEL.

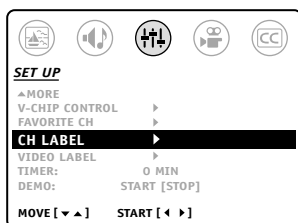

5. Press ◀ or ▶ to display the CH LABEL menu. SET/CLEAR will be highlighted.
6. Press ◀ or ▶ to highlight SET.
7. Press ▼ to highlight LABEL.

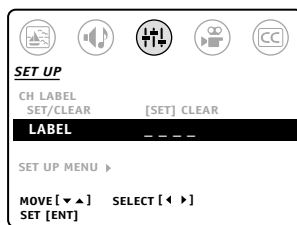
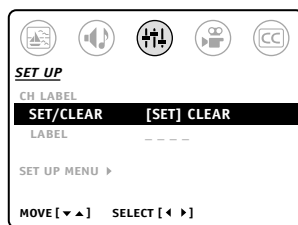

8. Press ◀ or ▶ repeatedly to scan through the list of available characters until the desired character appears in the first space.
  9. Press **MENU**.
  10. Repeat steps 8 and 9 to enter the rest of the characters.
- Note:** For a blank space in the label name, you must choose a blank space from the list of characters; otherwise, a dash will appear in the space.
11. Repeat steps 1–10 for up to 32 channels.
  12. Press **EXIT** to return to normal TV viewing.

### To erase a channel label:

1. Select the channel whose label you want to erase.
2. Press **MENU**.
3. Press ◀ or ▶ to highlight the SET UP menu.
4. Press ▲ or ▼ to highlight CH LABEL.
5. Press ◀ or ▶ to display the CH LABEL menu. SET/CLEAR will be highlighted.
6. Press ◀ or ▶ to highlight CLEAR.
7. Press **MENU**.
8. Repeat steps 1–7 to erase other channel labels, or press **EXIT** to return to normal TV viewing.

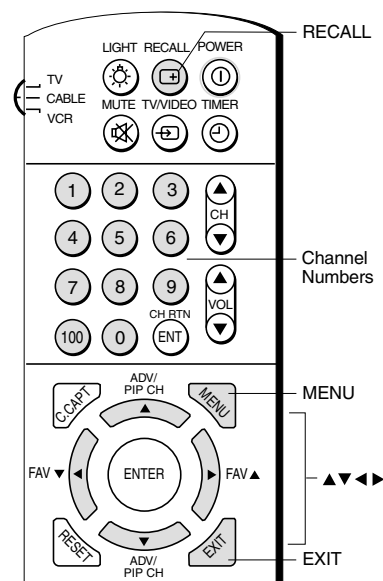

## Video labels

The Video Label feature allows you to label each input source for your TV, from the following preset list of labels:

–: Uses the default label name

VCR: Video cassette recorder

DVD: Digital video disc or digital versatile disc

DTV: Digital TV set-top box

SAT: Satellite box

CBL: Cable box

### To set up video labels:

1. Press **MENU**.
2. Press ◀ or ▶ to highlight the SET UP menu.
3. Press ▲ or ▼ to highlight VIDEO LABEL.
4. Press ◀ or ▶ to display the Video Label screen.
5. Press ▲ or ▼ to highlight the input source to be labeled (VIDEO 1, VIDEO 2, VIDEO 3, or ColorStream).
6. Press ◀ or ▶ to select the desired label for that input source.

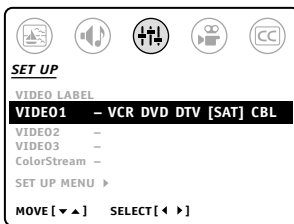

7. Repeat steps 1–6 to label the other input sources.
8. When you finish setting up video labels:
  - To return to the previous menu, press ▲ or ▼ to highlight SET UP MENU, and then press ◀ or ▶.
  - To return to normal TV viewing, press **EXIT**.

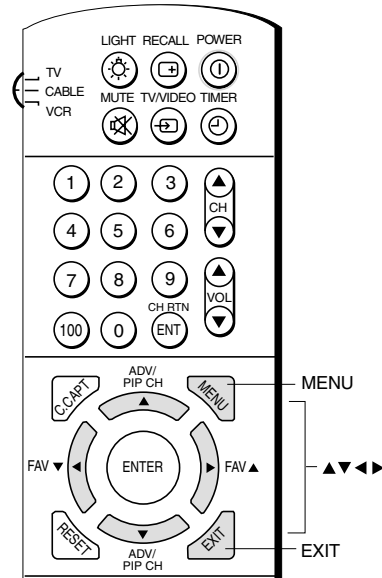

## Watching picture-in-picture (PIP)

The picture-in-picture (PIP) feature allows you to watch two pictures at the same time. The small PIP window can display a signal from a TV broadcast or an external source, such as a VCR.

### To display a TV broadcast in the PIP window:

1. Tune the TV to the program you want to watch in the main window.
2. Press **PIP** to display a small picture (one press displays a PIP window 1/9 the size of the screen; two presses display a 1/16-size window).

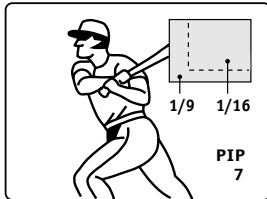

3. Press **PIP CH ▲▼** to change the PIP channel. Press **Channel ▲▼** to change the main channel.

### To display an external source in the PIP window:

1. Connect the external equipment to the ANT-1 connection on the TV.
 

**Note:** An ANT-2 source will not display as a PIP. For connection information, see "Connecting your TV" on page 7.
2. Turn on the TV and select the program/source you want to watch in the main window.
3. Press **PIP** (one press to display a PIP window 1/9 the size of the screen; two presses to display a 1/16-size window).
4. Press **SOURCE** to select the PIP input source (TV, VIDEO 1, VIDEO 2, or VIDEO 3). The current source will display on-screen in green.

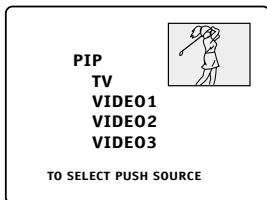

### To turn PIP off:

Press **PIP** two or three times, depending on the PIP window size you selected.

## Switching the main and small pictures

With the TV in PIP mode, repeatedly press **SWAP** to switch the main and small pictures back and forth.

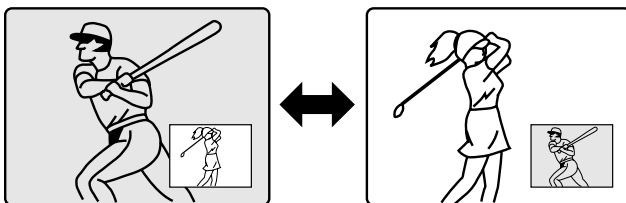

### Note:

The PIP window will not open when a ColorStream (component video) source is being viewed.

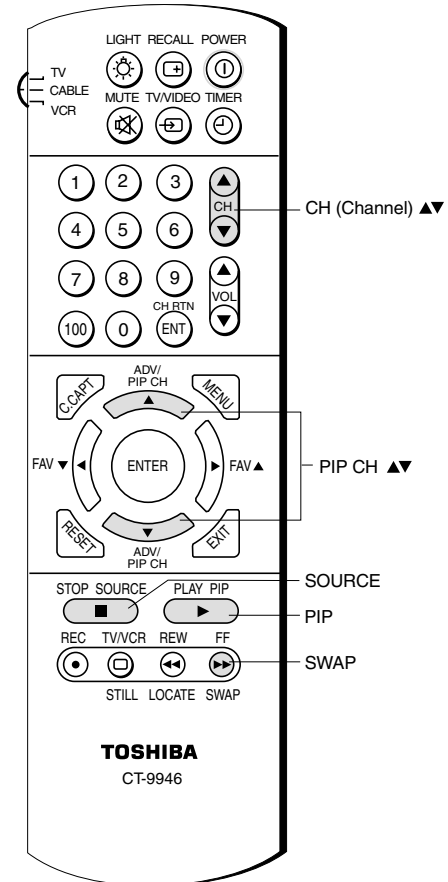

## Changing the location of the PIP window

With the TV in PIP mode, press **LOCATE** to change the location of the PIP window on-screen. Every time you press **LOCATE**, the PIP window changes position counter-clockwise.

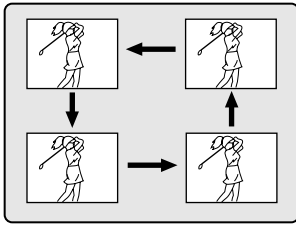

## Freezing the PIP display

With the TV in PIP mode, press **STILL** to freeze the PIP display. The PIP picture becomes still, and is outlined in red on-screen. Press **STILL** again to restore the moving picture (outlined in green).

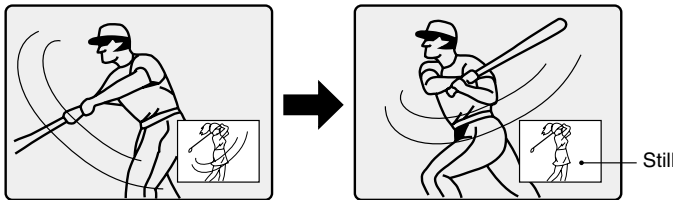

## Watching multi-window PIP

Multi-window PIP appears as six small boxes across the bottom of the screen. The multi-window PIP displays only the channels you programmed into the TV's memory (see "Adding channels to the TV's memory" on page 17).

**Note:** The **LOCATE**, **SWAP**, **PIP CHANNEL ▲▼**, **SOURCE**, and **STILL** buttons do not function in multi-window PIP mode.

### To view multi-window PIP:

Press **PIP** three times.

The TV cycles through all of the programmed channels, showing a few seconds of each channel's programming, and then freezes the image and moves on to the next channel in a continuous cycle. The channel number appears above each PIP window.

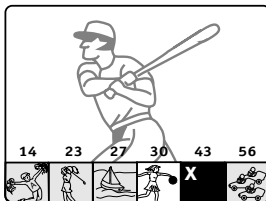

**Note:**

If V-Chip blocking is enabled when you view multi-window PIP, channels exceeding the rating limits will appear as a black window with a red "X."

### To turn multi-window PIP off:

Press **PIP** again, or change the channel.

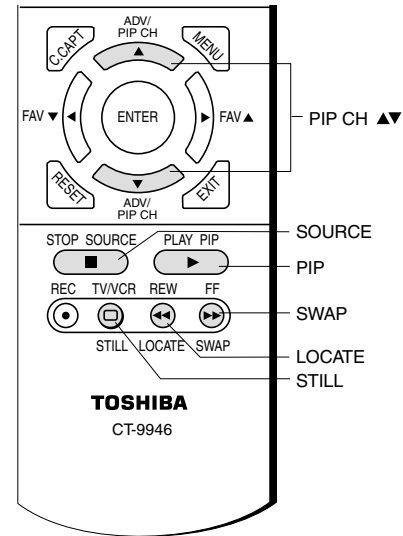

**Note:**

Multi-window PIP displays channels programmed for the signal source you are currently viewing (ANT-1 or Cable).

## Adjusting the picture

### Adjusting the picture quality

You can adjust the picture's contrast, brightness, sharpness, color, and tint. Your picture quality adjustments are stored automatically in the TV's memory. You can keep these settings or choose preset options in the PREFERENCE menu (see "Selecting the color temperature" below, and "Adjusting the picture preference" on the next page.)

#### To adjust the picture quality:

1. Press **MENU**.
2. Press ◀ or ▶ to highlight the PICTURE menu.
3. Press ▲ or ▼ until the quality you want to adjust is highlighted.

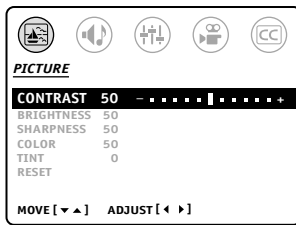

#### Note:

To reset the picture (and audio) adjustments to the factory settings, select **RESET** in the PICTURE menu.

4. Press ◀ or ▶ to adjust the level, as described in the following table:

Selection	◀ Pressing ▶	
Contrast	Lower	Higher
Brightness	Darker	Lighter
Sharpness	Softer	Sharper
Color	Paler	Deeper
Tint	Reddish	Greenish

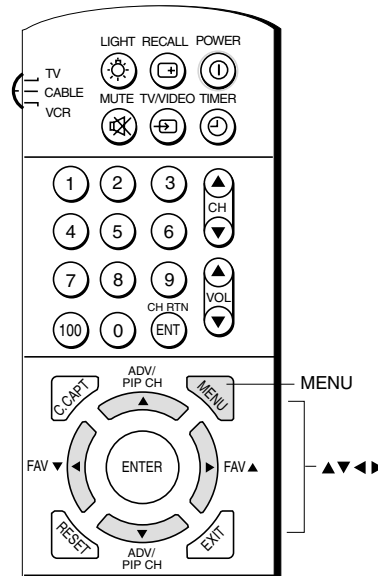
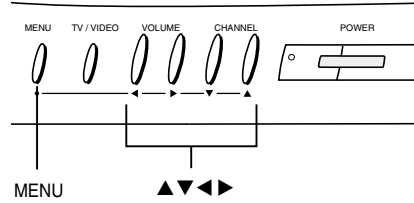

### Selecting the color temperature

You can change the picture quality by selecting from three preset color temperatures—cool, medium, and warm—as described in the following table:

Mode	Picture Quality
Cool	Blueish
Medium	Neutral
Warm	Reddish

#### To select the color temperature:

1. Press **MENU**.
2. Press ◀ or ▶ to highlight the PREFERENCE menu.
3. Press ▲ or ▼ to highlight COLOR TEMPERATURE.
4. Press ◀ or ▶ to highlight the mode you prefer.

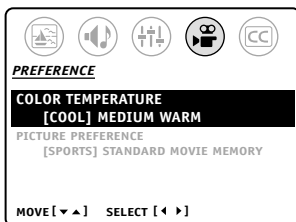

## Adjusting the picture preference

You can select four picture modes—Sports, Standard, Movie, and Memory—as described in the following table:

Mode	Picture Quality
Sports	Bright and dynamic picture (factory-set)
Standard	Standard picture quality (factory-set)
Movie	Movie-like picture setting (factory-set)
Memory	Your personal preferences (set by you; see “Adjusting the picture quality” on page 30.)

### To select your picture preference:

1. Press **MENU**.
2. Press ◀ or ▶ to highlight the PREFERENCE menu.
3. Press ▲ or ▼ to highlight PICTURE PREFERENCE.
4. Press ◀ or ▶ to highlight the mode you prefer.

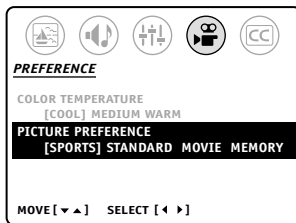

## Displaying on-screen information

Press **RECALL** to display the following information on-screen:

- Antenna mode (when in TV mode)
- Channel number or video mode
- Channel label (if set)
- Audio status (stereo or SAP)
- Rating of current program (if rated)

## Setting the off timer

The off timer turns the TV off automatically.

### To set the off timer:

1. Press **TIMER**.
2. Press ▶ to increase (or ◀ to decrease) the amount of time until the TV turns off automatically (in 10-minute increments, to a maximum of 180).
3. Press **EXIT** to exit the menu and return to normal TV viewing.

### To cancel the off timer:

Set the off timer to 0 (zero) minutes in step 2 above, or turn the TV off and then on again.

## Auto power off

The TV turns itself off automatically after approximately 15 minutes if it is tuned to a vacant channel or a station that stops broadcasting for the day.

**Note:** The auto power off feature does not work in VIDEO mode.

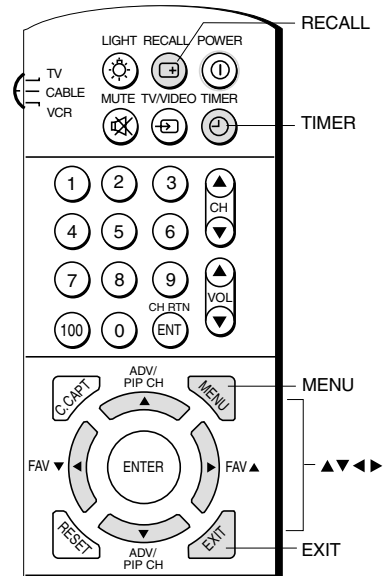
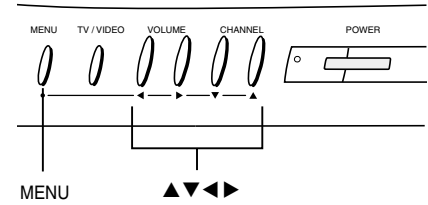

## Using the closed caption feature

The Closed Caption feature has two options:

- Captions—An on-screen display of the dialogue, narration, and sound effects of programs and videos that are closed-captioned (usually identified in your local TV listing as “CC”).
- Text—An on-screen display of information not related to the program, such as weather or stock data (if available in your viewing area).

### To view captions or text:

1. Tune the TV to the desired program.
2. Press **C.CAPT** (or press **MENU**, and then press ◀ or ▶ to highlight the CLOSED CAPTION menu).
3. Press ▲ or ▼ to highlight CC.

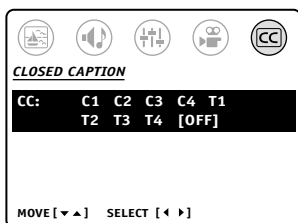

4. Press ◀ or ▶ to select the desired Closed Caption mode, as follows:
  - To view captions, select C1, C2, C3, or C4 (C1 displays translation of the primary language in your area). **Note:** If the program or video you selected is not closed-captioned, no captions will display on the screen.

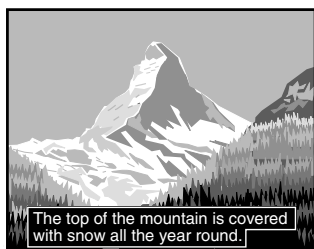

- To view text, select T1, T2, T3, or T4. **Note:** If text is not available in your viewing area, a black rectangle may appear on your screen. If this occurs, turn the Closed Caption feature off.

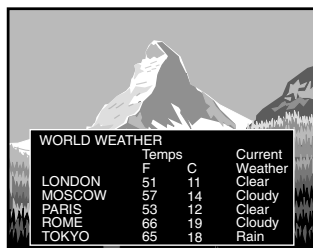

- To turn the Closed Caption feature off, highlight OFF in the Closed Caption menu.

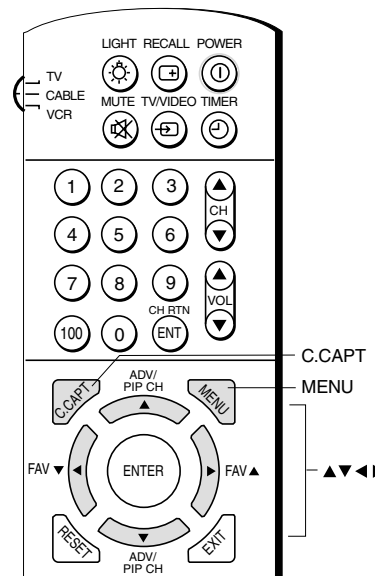

### Note:

A closed caption signal may not display in the following situations:

- When a videotape has been dubbed
- When the signal reception is weak
- When the signal reception is non-standard



## Adjusting the sound

### Muting the sound

Press **MUTE** to temporarily turn off the sound. While the sound is off, the screen displays the word “MUTE” in the lower /right corner. To restore the sound, press **MUTE** or **VOLUME ▲▼**.

When you press **MUTE**, the Closed Caption feature is automatically activated. To deactivate captions and restore normal sound, press **MUTE** again. This feature works only when the Closed Caption mode is set to OFF. See “Using the closed captioned feature” on page 40 for more information about closed caption settings.

### Selecting stereo/SAP broadcasts

The multi-channel TV sound (MTS) feature provides high-fidelity stereo sound. MTS also can transmit a second audio program (SAP) containing a second language or other audio information.

**Note:** The MTS feature is not available in VIDEO mode.

In general, you can leave your TV in stereo mode because the TV automatically outputs either stereo or monaural (“mono”) sound, depending on the broadcast type.

When the TV receives a stereo or SAP broadcast, the word “STEREO” or “SAP” displays on the screen every time you turn the TV on, change the channel, or press **RECALL**.

#### To listen to stereo sound:

1. Press **MENU**.
2. Press ◀ or ▶ to highlight the AUDIO menu.
3. Press ▲ or ▼ to highlight MTS.
4. Press ◀ or ▶ to highlight STR (stereo).

**Note:** If the stereo sound is noisy, select MONO to reduce the noise.

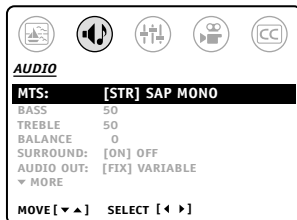

#### To listen to a second audio program (SAP):

1. Press **MENU**.
2. Press ◀ or ▶ to highlight the AUDIO menu.
3. Press ▲ or ▼ to highlight MTS.
4. Press ◀ or ▶ to highlight SAP. The TV speakers will output only the second audio program.

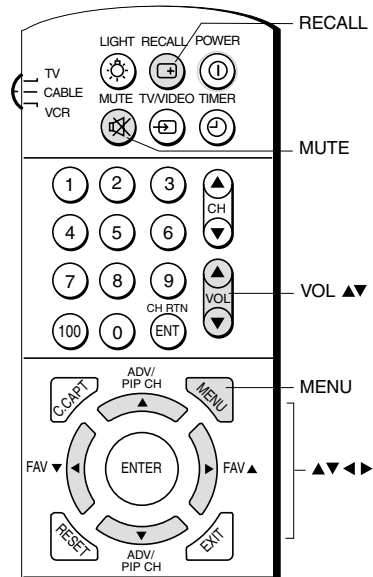

## Adjusting the sound quality

You can change the sound quality of your TV by adjusting the bass, treble, and balance.

### To adjust the sound quality:

1. Press **MENU**.
2. Press ◀ or ▶ to highlight the AUDIO menu.
3. Press ▲ or ▼ to highlight the quality you want to adjust.
4. Press ◀ or ▶ to adjust the level:
  - ◀ makes the sound quality weaker or decreases the balance in the right channel, depending on the item selected.
  - ▶ makes the sound quality stronger or decreases the balance in the left channel, depending on the item selected.

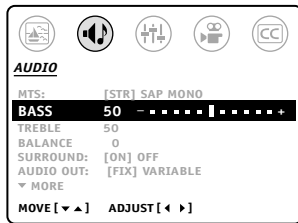

## Using the surround sound feature

The surround sound feature expands the audio listening field wider and deeper to create exceptional sound quality from the TV speakers. This feature uses stereo signals from a TV broadcast or video input.

### To turn the surround sound feature on:

1. Press **MENU**.
2. Press ◀ or ▶ to highlight the AUDIO menu.
3. If you have not already done so, select STEREO mode (press ▲ or ▼ to highlight MTS, and then press ◀ or ▶ to highlight STR).
4. Press ▲ or ▼ to highlight SURROUND.
5. Press ◀ or ▶ to highlight ON.

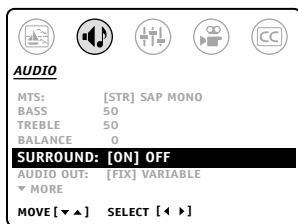

### To turn the surround sound feature off:

Highlight OFF in step 5 above. **Note:** In general, you can leave the surround sound feature on because it automatically outputs surround stereo or monaural sound, depending on the broadcast or video type.

### Note:

To reset the audio adjustments (bass, treble, and balance) to the factory settings, select **RESET** in the **PICTURE** menu (see page 30).

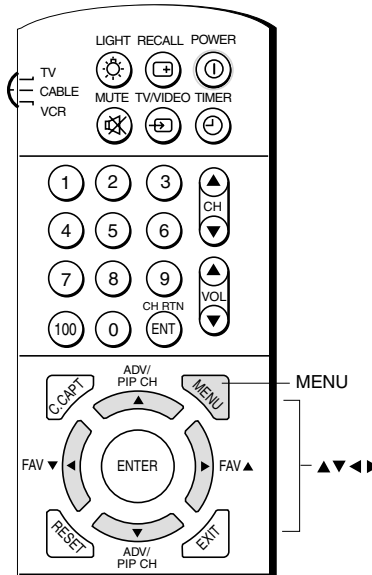
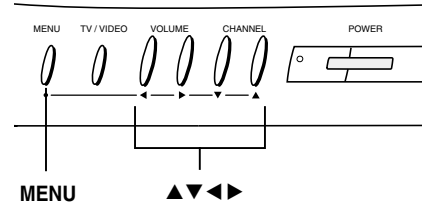

## Selecting variable audio OUT

If you connect external audio equipment (such as a stereo audio amplifier or surround sound system) to the TV's Audio OUT jack, you can use the AUDIO OUT feature to select either variable or fixed audio output.

- If you set AUDIO OUT to VARIABLE, you can use the volume controls on either the TV or the audio equipment to adjust the sound level coming through the audio equipment.
- If you set AUDIO OUT to FIX, you must use the volume controls on the audio equipment to adjust the sound level coming through the audio equipment (the TV's volume setting will have no effect).

**Note:** Fixed audio output provides a cleaner signal than variable audio output.

See page 11 for details on connecting an audio amplifier to the TV's Audio OUT jack.

### To select variable audio output:

1. Press **MENU**.
2. Press ◀ or ▶ to highlight the AUDIO menu.
3. Press ▲ or ▼ to highlight AUDIO OUT.
4. Press ◀ or ▶ to highlight VARIABLE.

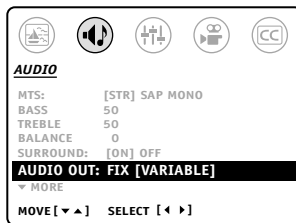

### To select fixed audio output:

1. Highlight FIX in step 4 above.

## Turning off the built-in speakers

Use this feature to turn off the TV's built-in speakers when you connect external speakers to your TV (see "Connecting an audio amplifier" on page 11).

### To turn off the built-in speakers:

1. Press **MENU**.
2. Press ◀ or ▶ to highlight the AUDIO menu.
3. Press ▲ or ▼ to highlight SPEAKERS.
4. Press ◀ or ▶ to highlight OFF.

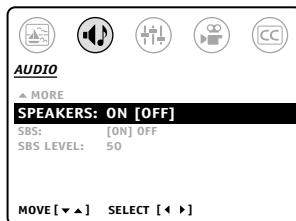

### To turn on the built-in speakers:

1. Highlight ON in step 4 above.

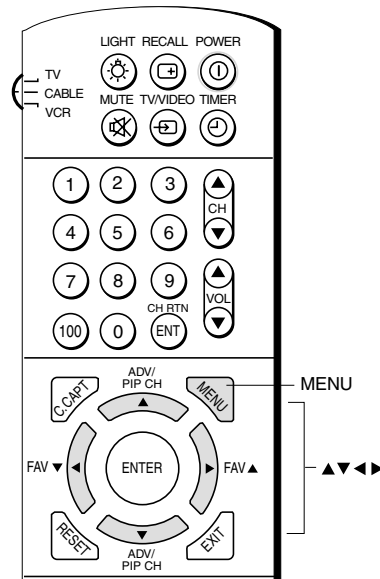
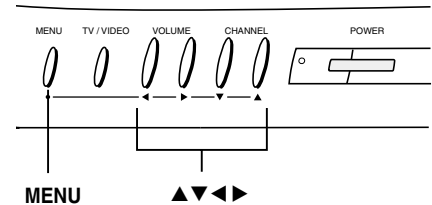

## Using the sub-bass system (SBS)

The sub-bass system (SBS) allows you to enhance bass performance, even when the volume is low.

### To turn the sub-bass system on (or off):

1. Press **MENU**.
2. Press ◀ or ▶ to highlight the AUDIO menu.
3. Press ▲ or ▼ to highlight SBS.
4. Press ◀ or ▶ to highlight ON (or OFF).

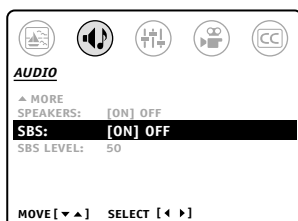

### To adjust the sub-bass system:

1. Turn the sub-bass system on, as instructed above.
2. Press **MENU**.
3. Press ◀ or ▶ to highlight the AUDIO menu.
4. Press ▲ or ▼ to highlight SBS LEVEL.
5. Press ◀ or ▶ to adjust the SBS level.

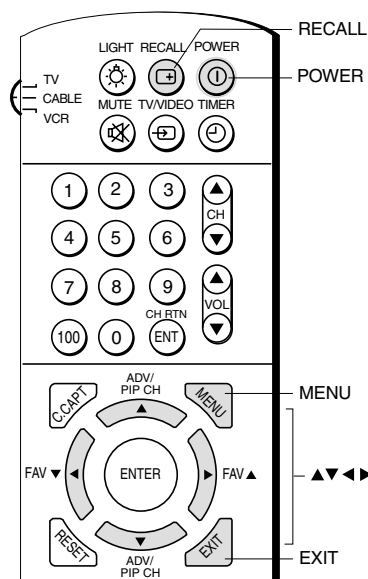
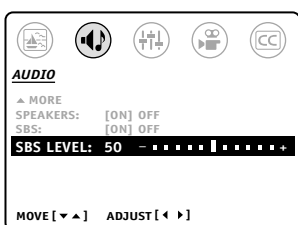

## Viewing the demonstration (DEMO) mode

The demonstration (DEMO) mode is an option available on the SET UP menu that will demonstrate several features of your TV.

### To start the demonstration mode:

1. Press **MENU**.
2. Press ◀ or ▶ to highlight the SET UP menu.
3. Press ▲ or ▼ to highlight DEMO.
4. Press ◀ or ▶ to highlight START.
4. Press **MENU** to start the demo.

### To stop the demonstration mode:

Press **RECALL**, **EXIT**, or **POWER**.

## Understanding the last mode memory feature

If the power is cut off while you are viewing the TV, the Last Mode Memory feature turns the TV on automatically when the power is resupplied.

If the power is going to be off for a long time and you are going to be away from your TV, unplug the power cord to prevent the TV from turning on in your absence.

# Appendix

## Troubleshooting

Before calling a service technician, please check the following table for possible causes of the problem and some solutions.

<b>Problem</b>	<b>Solution</b>
TV will not turn on	<ul style="list-style-type: none"> <li>• Make sure the power cord is plugged in, and then press <b>POWER</b>.</li> <li>• The remote control batteries may be dead. Replace the batteries or press the <b>POWER</b> button on the TV.</li> </ul>
No picture, no sound	<ul style="list-style-type: none"> <li>• Check the antenna/cable connections.</li> </ul>
No sound, picture OK	<ul style="list-style-type: none"> <li>• The sound may be muted. Press <b>MUTE</b> or <b>VOLUME ▲▼</b>.</li> <li>• The station may have broadcast difficulties. Try another channel.</li> </ul>
Poor sound, picture OK	<ul style="list-style-type: none"> <li>• The station may have broadcast difficulties. Try another channel.</li> </ul>
Poor picture, sound OK	<ul style="list-style-type: none"> <li>• Check the antenna connections.</li> <li>• The station may have broadcast difficulties. Try another channel.</li> <li>• Adjust the PICTURE menu.</li> </ul>
Poor reception of broadcast channels	<ul style="list-style-type: none"> <li>• The station may have broadcast difficulties. Try another channel.</li> <li>• Check the antenna connections.</li> <li>• If you are using a VCR, make sure the TV/VCR button is set correctly.</li> </ul>
Cannot receive above channel 13	<ul style="list-style-type: none"> <li>• Make sure TV/CABLE is set to TV mode.</li> </ul>
Unable to select a certain channel	<ul style="list-style-type: none"> <li>• The channel may be locked out with the channel lock feature, or erased with the add/erase feature.</li> </ul>
Multiple images	<ul style="list-style-type: none"> <li>• The station may have broadcast difficulties. Try another channel.</li> <li>• Use a highly directional outdoor antenna.</li> </ul>
Poor color or no color	<ul style="list-style-type: none"> <li>• The station may have broadcast difficulties. Try another channel.</li> <li>• Adjust the TINT and/or COLOR in the PICTURE menu.</li> <li>• If you change the direction of the TV while it is turned on, the picture could suffer from color shading. If so, turn the TV off and allow it to cool down for several hours before turning it on again.</li> </ul>
No stereo or SAP sound from a known MTS broadcast	<ul style="list-style-type: none"> <li>• Make sure the MTS feature is set properly.</li> </ul>
The remote control does not operate	<ul style="list-style-type: none"> <li>• Check that the TV/CABLE/VCR switch is properly set.</li> <li>• There may be an obstruction between the remote control and the remote control sensor.</li> <li>• The remote control batteries may be dead. Replace the batteries.</li> </ul>
The V-Chip PIN code does not work	<ul style="list-style-type: none"> <li>• Change or reset your PIN code.</li> </ul>

## Cleaning and care

**WARNING: TV sets use high voltage. Do not remove the cabinet back.  
Refer all servicing to a qualified service technician.**

### To clean the TV screen and cabinet:

1. Unplug the power cord to avoid possible shock hazard.
2. Use a clean cellulose sponge or chamois cloth dampened with a solution of mild detergent and warm water to clean the TV screen and trim. Do not use too much water; liquid spilling into the cabinet can damage the TV.
3. Wipe off excess moisture with a clean dry cloth.
4. Polish the cabinet with a quality furniture polish to maintain the finish and appearance of the cabinet.

#### **Caution:**

*Never use strong solvents such as thinner, benzene, or other chemicals on or near the cabinet.  
These chemicals can damage the cabinet's finish.*

## Specifications

Television system	NTSC standard
Channel coverage	VHF: 2 through 13 UHF: 14 through 69 Cable TV: Mid band (A-8 through A-1, A through 1) Super band (J through W) Hyper band (AA through ZZ, AAA, BBB) Ultra band (65 through 94, 100 through 125)
Power source	120 AC, 60 Hz
Power consumption	96 W
Audio power	5 W + 5 W
Speaker type	2-3/8 x 4-3/4 inches (60 x 120 mm)
Video/Audio terminals	ColorStream™ (component video) INPUT Y: 1V (p-p), 75 ohm C <sub>R</sub> (P <sub>R</sub> ): 0.7 V (p-p), 75 ohm C <sub>B</sub> (P <sub>B</sub> ): 0.7 V (p-p), 75 ohm S-VIDEO INPUT Y-INPUT: 1 V (p-p), 75 ohm, negative sync. C-INPUT: 0.286 V (p-p) (burst signal), 75 ohm VIDEO/AUDIO INPUT VIDEO: 1 V (p-p), 75 ohm, negative sync. AUDIO: 150 mV (rms) (30% modulation equivalent, 47 k ohm) VIDEO/AUDIO OUTPUT VIDEO: 1 V (p-p), 75 ohm, negative sync. AUDIO: 150 mV (rms) (30% modulation equivalent, 47 k ohm)
Dimensions	Width: 38-3/16 inches (970 mm) Height: 30-1/16 inches (764 mm) Depth: 25-1/4 inches (641 mm)
Weight	154 lbs (69.9 kg)
Supplied accessories	Remote control with two size "AA" batteries
Optional TV stand	ST-3641

**Design and specifications are subject to change without notice.**

# Limited United States warranty

Toshiba America Consumer Products, Inc. ("TACP") and Toshiba Hawaii Inc. ("THI") make the following limited warranties. These limited warranties extend to the original consumer purchaser or any person receiving this set as a gift from the original consumer purchaser and to no other purchaser or transferee.

## Limited One (1) Year Warranty

TACP and THI warrant this product and its parts against defects in materials or workmanship for a period of one (1) year after the date of original retail purchase. During this period, TACP and THI will repair or replace a defective part, at their option, with a new or refurbished part, without charge to you. TACP/THI Authorized Service Center personnel will come to your home when warranty service is required. Depending on the type of repair required, either the service will be performed in your home or the set will be taken to the TACP/THI authorized service center for repair and returned to your home at no cost to you.

## Limited Two (2) Year Warranty of Picture Tube

TACP and THI further warrant the picture tube in this product against defects in materials or workmanship for a period of two (2) years after the date of original retail purchase. During this period, TACP and THI will repair or replace a defective picture tube at their option, with a new or refurbished picture tube, without charge to you, except that, if a defective picture tube is replaced after one (1) year from the date of the original retail purchase, you pay labor charges involved in the replacement.

## Rental Units

The warranty for rental units begins with the first rental or thirty (30) days from the date of shipment to the rental firm, whichever comes first.

## Commercial Units

Products sold and used for commercial use have a limited ninety (90) day warranty for all parts, labor and picture tube.

## How to Obtain Warranty Service

If after following all of the operating instructions in this manual and checking the "Troubleshooting" section, you find that service is needed:

- (1) To find the nearest Toshiba Authorized Service Center, visit our web site at [www.toshiba.com/tacp](http://www.toshiba.com/tacp) and click "Customer Solutions," or call us toll-free at 1-800-631-3811.  
In Hawaii, contact Toshiba Hawaii, Inc., Service, 327 Kamakee Street, Honolulu, HI 96814, (808) 591-9281.
- (2) Present your bill of sale or other proof of purchase to the Authorized Service Center. "Authorized TACP/THI service center personnel will come to your home when warranty service is required. Depending on the type of repair required, either the service will be performed in your home or the TV set will be taken to the TACP/THI authorized service center for repair and returned to your home at no cost to you."

**For additional information, visit our web site:  
[www.toshiba.com/tacp](http://www.toshiba.com/tacp)**

All warranties implied by state law, including the implied warranties of merchantability and fitness for a particular purpose, are expressly limited to the duration of the limited warranties set forth above. With the exception of any warranties implied by state law as hereby limited, the foregoing warranty is exclusive and in lieu of all other warranties, guarantees, agreements and similar obligations of manufacturer or seller with respect to the repair or replacement of any parts. In no event shall TACP or THI be liable for consequential or incidental damages.

No person, agent, distributor, dealer or company is authorized to change, modify or extend the terms of these warranties in any manner whatsoever. The time within which action must be commenced to enforce any obligation of TACP or THI arising under this warranty or under any state or law of the United States or any state thereof, is hereby limited to 90 days from the date you discover, or should have discovered, the defect. This limitation does not apply to implied warranties arising under state law.

This warranty gives you specific legal rights and you may also have other rights which may vary from state to state. Some states do not allow limitation on how long an implied warranty lasts, when an action may be brought, or the exclusion or limitation of incidental or consequential damages; therefore, the above provisions may not apply to you.



## ATTENTION CANADIAN CONSUMERS

Canadian consumers are requested to complete the special Canadian "Warranty Registration Form" enclosed, and forward this completed form with a copy of the bill of sale to TOSHIBA OF CANADA to "Register and Validate" their warranty.

Products purchased in the U.S.A. and used in Canada are not covered by these warranties.  
Products purchased in Canada and used in the U.S.A. are not covered by these warranties.

REV. 03/01

**Toshiba America  
Consumer Products, Inc.**

**Head Office**  
82 Totowa Road  
Wayne, NJ 07470

**National Service Division**  
1420B Toshiba Drive  
Lebanon, TN 37087

**Toshiba Hawaii, Inc.**

**Head Office**  
327 Kamakee Street  
Honolulu, HI 96814

**Toshiba of Canada, Ltd.**

**Head Office**  
191 McNabb Street  
Markham, Ontario L3R 8H2  
Canada

**Service Centers**

**Toronto**  
191 McNabb Street  
Markham, Ontario L3R 8H2  
Canada  
Tel: (905) 470-5400

**Montreal**  
1643 North Service Road  
Trans-Canada Highway  
Dorval, Quebec H9P 1J1  
Canada  
Tel: (514) 856-4100

**Vancouver**  
22171 Fraserwood Way  
Richmond, British Columbia V6W 1J5  
Tel: (604) 303-2500

Manufactured by:

**TOSHIBA**

**Toshiba America  
Consumer Products, Inc.**

PRINTED IN USA  
(01-04)B

23565245